



# KS 3012

## Data Monitor with Compact Flash Operation and parameterization



**Manual**  
**9499-040-76111**

Valid from : 01/2005

# Menu structure of the paperless recorder

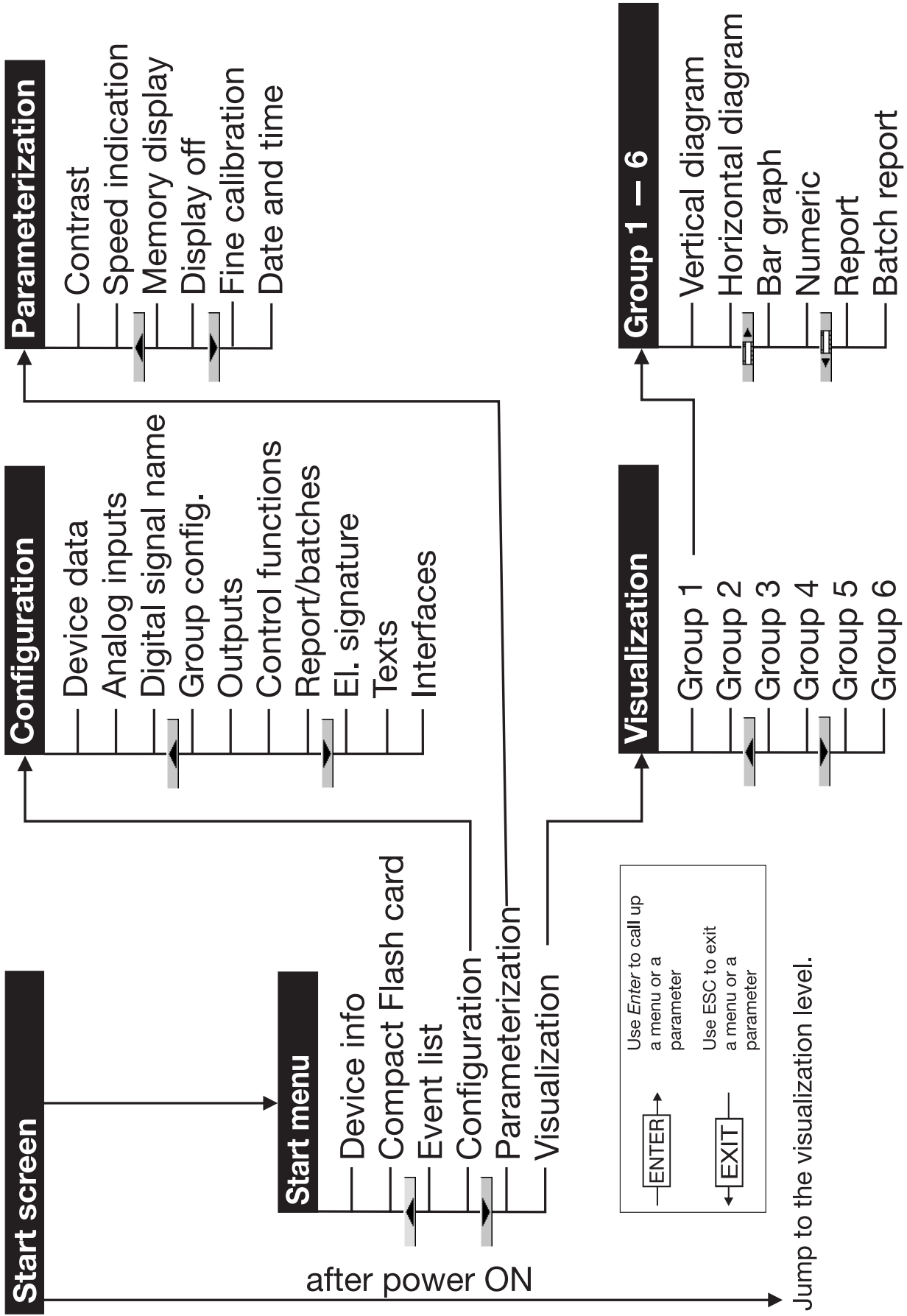

<b>1</b>	<b>Introduction</b>	<b>7</b>
1.1	Preface .....	7
1.2	Arrangement of the documentation .....	8
1.3	Typographical conventions .....	10
<b>2</b>	<b>Instrument description</b>	<b>13</b>
2.1	Displays and controls .....	13
2.2	Operating principle and graphic elements .....	16
2.3	Analog inputs .....	18
2.4	Digital signals .....	19
2.5	Counters .....	22
2.6	Integrator .....	23
2.7	Operating modes .....	24
2.8	Storing data .....	25
2.9	Reading out data .....	26
2.10	Evaluating data .....	26
<b>3</b>	<b>Operation and visualization</b>	<b>27</b>
3.1	Start menu .....	28
3.1.1	Overview .....	28
3.1.2	Logging in and logging off .....	29
3.2	Visualization .....	33
3.2.1	Vertical diagram .....	34
3.2.2	Horizontal diagram .....	35
3.2.3	Evaluation of the stored measurement data .....	36
3.2.4	Bar graph representation .....	39
3.2.5	Numerical representation .....	40
3.2.6	Numerical 1-channel representation .....	41
3.2.7	Reports .....	42
3.2.8	Batch reports .....	43
3.3	Parameterization .....	52
3.4	Configuration .....	55
3.5	Event list .....	56

---

# Contents

---

<b>3.6</b>	<b>CompactFlash card</b> .....	<b>59</b>
<b>3.7</b>	<b>Device info</b> .....	<b>63</b>
<b>3.8</b>	<b>Text entry</b> .....	<b>65</b>
<b>4</b>	<b>Configuration parameters</b> .....	<b>67</b>
<b>4.1</b>	<b>Operating example</b> .....	<b>67</b>
<b>4.2</b>	<b>Table of configuration parameters</b> .....	<b>68</b>
4.2.1	Parameterization .....	69
4.2.2	Configuration .....	71
<b>5</b>	<b>Setup software</b> .....	<b>89</b>
<b>5.1</b>	<b>Hardware and software requirements</b> .....	<b>89</b>
<b>5.2</b>	<b>Installation</b> .....	<b>90</b>
<b>5.3</b>	<b>User interface</b> .....	<b>91</b>
<b>5.4</b>	<b>Configuration</b> .....	<b>93</b>
<b>5.5</b>	<b>Teleservice</b> .....	<b>96</b>
<b>5.6</b>	<b>Data transfer from and to the device</b> .....	<b>98</b>
5.6.1	Transfer via CompactFlash memory card .....	98
5.6.2	Transfer via interface .....	99
<b>5.7</b>	<b>Connection between the PC and the recorder</b> .....	<b>100</b>
5.7.1	Assistant for Device Settings .....	100
5.7.2	Device list .....	104
5.7.3	Incorrect log-in to device .....	105
<b>5.8</b>	<b>Menu functions</b> .....	<b>106</b>
5.8.1	File .....	106
5.8.2	Editing .....	107
5.8.3	Data transfer .....	108
5.8.4	Extras .....	108
5.8.5	Window .....	114
5.8.6	Info .....	115
<b>5.9</b>	<b>Character set</b> .....	<b>116</b>
<b>6</b>	<b>Rights</b> .....	<b>119</b>
<b>6.1</b>	<b>Rights regarding the PC Setup software</b> .....	<b>119</b>
<b>6.2</b>	<b>Rights regarding the paperless recorder</b> .....	<b>120</b>

---

**7 Index**

**121**

# Contents

---

---

## 1.1 Preface



Please read this Operating Manual before commissioning the instrument. Keep the manual in a place that is accessible to all users at all times.

Please assist us to improve this operating manual, where necessary.

Your suggestions will be appreciated.



However, if any difficulties should arise during start-up, please do not carry out any manipulations. You could endanger your rights under the instrument warranty!

Please contact the nearest subsidiary or the head office in such a case.



When returning modules, assemblies or components, the regulations of EN 61340-5-1 and 61340-5-2 "Protection of electronic devices from electrostatic phenomena" must be observed. Use only the appropriate **ESD** packaging for transport.

Please note that we cannot accept any liability for damage caused by ESD.

ESD=electrostatic discharge

# 1 Introduction

---

## 1.2 Arrangement of the documentation

The documentation for this instrument is addressed to equipment manufacturers (OEMs) and users with appropriate technical expertise. It consists of the following parts:

### Instrument documentation in printed form

#### **Operating Instructions 9499-040-76211**

The operating instructions are an extract from the operating manual and cover the basic operation of the paperless recorder.

#### **Installation Instructions 9499-040-76011**

The installation instructions describe the installation of the recorder and the connection of the supply and signal cables. The instructions also contain a list of the technical data.

### Instrument documentation in the form of PDF files

The “Instrument documentation in the form of PDF files” is on the CD that comes with the delivery.

#### **Operating Manual 9499-040-76111**

It contains information about commissioning, operation and parameterization on the instrument, as well as about the PC setup program (available as an option).

#### **Operating Instructions 9499-040-76211**

The operating instructions are an extract from the operating manual and cover the basic operation of the paperless recorder.

#### **Interface Description (serial interfaces) 9499-040-76311**

This provides information on the communication (RS232; RS422/RS485) with supervisory systems.

#### **Interface Description (Ethernet interface)**

This provides information on the connection of a paperless recorder to a company-internal network. The description is integrated in the 9499-040-76311.

#### **Interface Description (PROFIBUS-DP interface) 9499-040-76511**

This provides information on the connection of a paperless recorder to a PROFIBUS-DP system.

#### **Installation Instructions 9499-040-76011**

The installation instructions describe the installation of the recorder and the connection of the supply and signal cables. The instructions also contain a list of the technical data.



## **PC Evaluation Software (PCA3000) 9499-040-76611**

The operating manual describes the operation and the features of the PC evaluation software.

PCA3000 serves to visualize and evaluate process data (measurement data, batch data, messages, instrument audit trails, ...). The process data can be read in via the CompactFlash memory card, or made available through the PCC software.

## **PCA Communications Software (PCC) 9499-040-76711**

The operating manual describes the operation and the features of the PCA communications software.

PCC is responsible for the data transfer from the recorder to a PC, or to a network.

# 1 Introduction

---

## 1.3 Typographical conventions

### Warning signs

The symbols for **Danger** and **Caution** are used in this manual under the following conditions:



#### **Danger**

This symbol is used when there may be **danger to personnel** if the instructions are ignored or not followed correctly!



#### **Caution**

This symbol is used when there may be **damage to equipment or data** if the instructions are ignored or not followed correctly!



#### **Caution**

This symbol is used where special care is required when handling **components liable to damage through electrostatic discharge**.

### Note signs



#### **Note**

This symbol is used when your **special attention** is drawn to a remark.



#### **Reference**

This symbol refers to **further information** in other manuals, chapters or sections.

abc<sup>1</sup>

#### **Footnote**

Footnotes are remarks that **refer to specific points** in the text. Footnotes consist of two parts:

A marker in the text, and the footnote text.

The markers in the text are arranged as continuous superscript numbers.

#### **Action**

\*

This symbol indicates that an **action to be performed** is described.

The individual steps are marked by this asterisk, e.g.

\* Press the  key

\* Confirm with 

## Representation

### Keys

 + 

Keys are **shown in a box**. Both **symbols and text** are possible. If a key has a multiple function, then the text shown is the one that corresponds to the function **that is active at the moment**.

### Screen texts

*Program  
Manager*

Texts that are displayed in the setup program are indicated by **italic script**.

### Menu items

*Edit →  
device data*

Menu items in the setup and instrument software referred to in this manual are shown in italics. Menu name, menu item and submenu item are separated from each other by “→”.

# 1 Introduction

---

## 2 Instrument description

### 2.1 Displays and controls

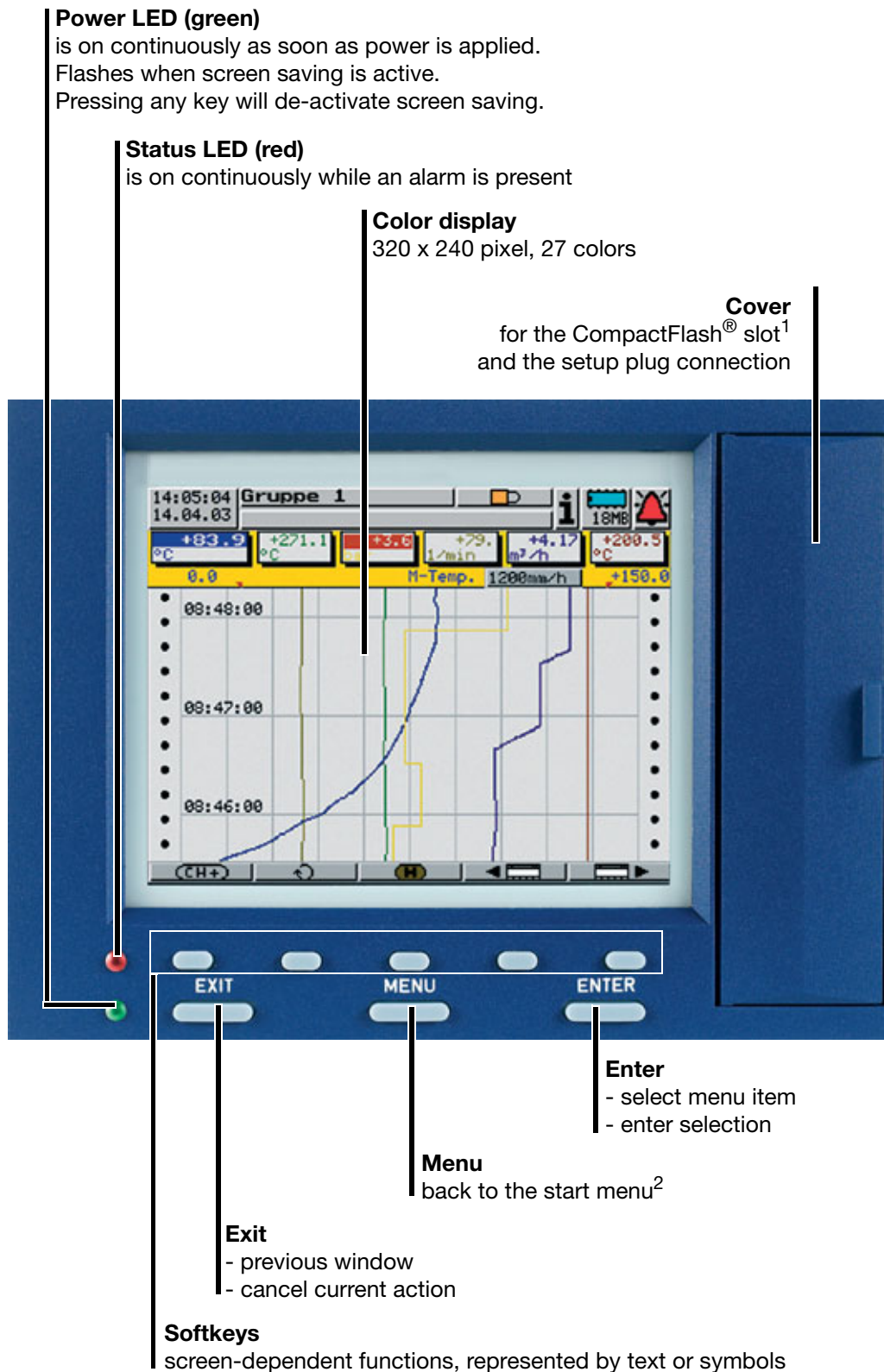

1. CompactFlash<sup>®</sup> is a registered trademark of the SanDisk Corporation.

2. Not from the configuration level if a parameter has already been modified there.

## 2 Instrument description

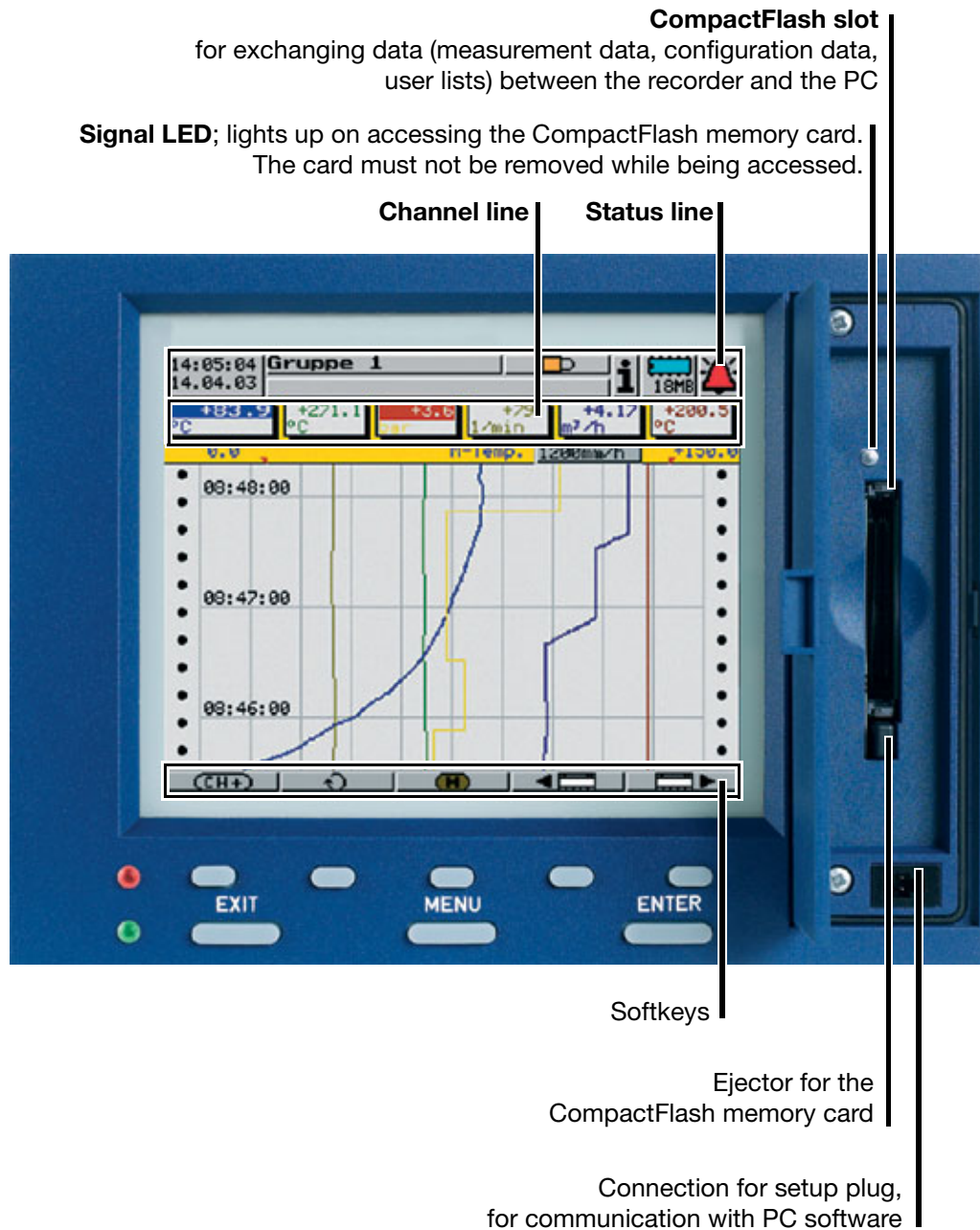

The life of the background illumination can be prolonged through the parameter "Display off" (screen saving).

⇒ Chapter 4 "Configuration parameters",  
*Parameterization* → *Display off*



The CompactFlash memory card must not be removed during access (signal LED is on).

## 2 Instrument description

Version with  
stainless steel  
front

### Status LED (red)

is on continuously while an alarm is present

### Power LED (green)

is on continuously as soon as power is applied.

Flashes when screen saving is active.

Pressing any key will de-activate screen saving.

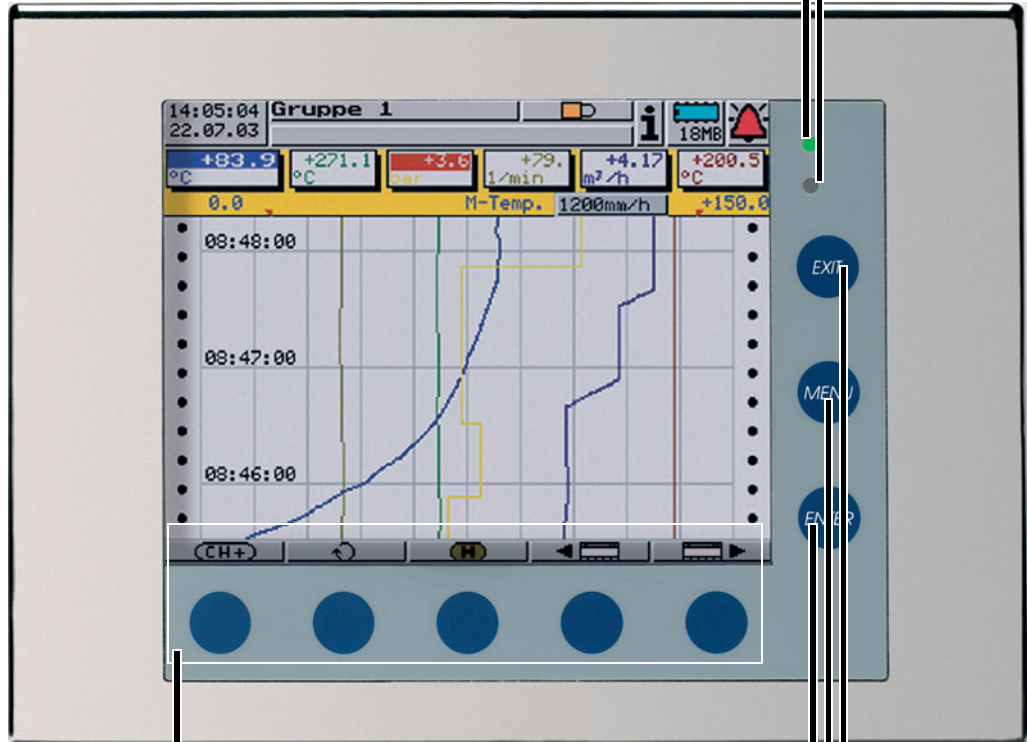

### Softkeys

screen-dependent function,  
represented by text or symbols

### Exit

- previous window
- cancel current action

### Menu

back to the start menu

### Enter

- select menu item
- enter selection



On the stainless steel version, the CompactFlash slot and the setup plug connection are located at the instrument rear.

# 2 Instrument description

## 2.2 Operating principle and graphic elements

**Keys** The recorder is operated from eight keys. Three of these have fixed functions, the other five (softkeys) have screen-dependent functions.  
⇒ Chapter 2.1 “Displays and controls”

**Softkeys** The functions of the softkeys appear in the bottom line of the display, as symbols or in plain text.



**Status line** The status line is shown in the top section of the display. It provides information on important actions and states. The status line is always visible, irrespective of the level (operation, parameters, configuration).

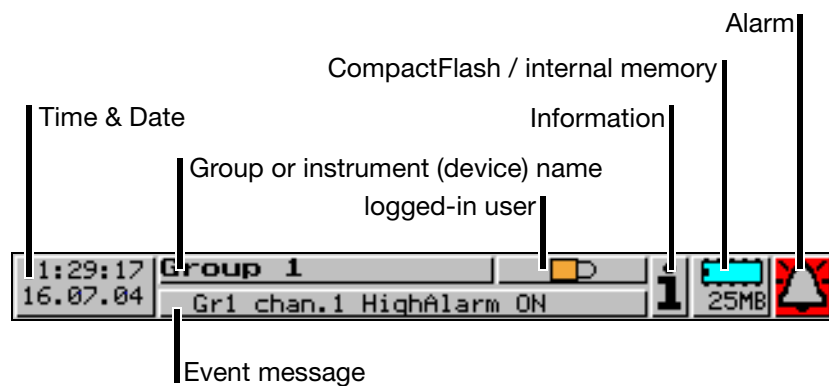

### Time & Date

shows the current time and date

### Group or instrument name

The visualization displays show the group name. All other menus show the instrument name.

### Logged-in user

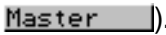
If the symbol  appears in the display, no user is logged into the recorder. If somebody is logged in, then the user name is shown here (e.g. ).

### Event message

shows last entry in event list

### Information



The egg timer appears whenever the instrument is busy and can therefore not be operated.



The “H” informs you that the indicated measurements are derived from the past (history). The data in the RAM are shown.



In the event of an error, an “i” flashes here. The cause of the error can be read out from the instrument (device) info window (⇒ Chapter 3.7 “Device info”).



If the keys are inhibited, a key flashes in this position.



## 2 Instrument description

### CompactFlash / internal memory

indicates the free capacity of the CompactFlash memory or the internal backup memory. Which symbol is shown, can be set in the "Parameterization" menu.

⇒ Chapter 4.2.1 "Parameterization"

⇒ Chapter 3.6 "CompactFlash card"



Free capacity of the CompactFlash memory card.



Free capacity of the internal backup memory.

This turquoise symbol is shown when the data are read out via the CompactFlash memory card.



Free capacity of the internal backup memory.

This dark blue symbol is shown when the data are read out via the serial interface or the Ethernet interface.

### Alarm

If an alarm occurs (e.g. out-of-limit), the (alarm) bell flashes in this field.

### Channel line

The channel line shows the measured values for the active channels of the group together with their unit. In addition, alarms and out-of-range conditions are made directly visible in this line.

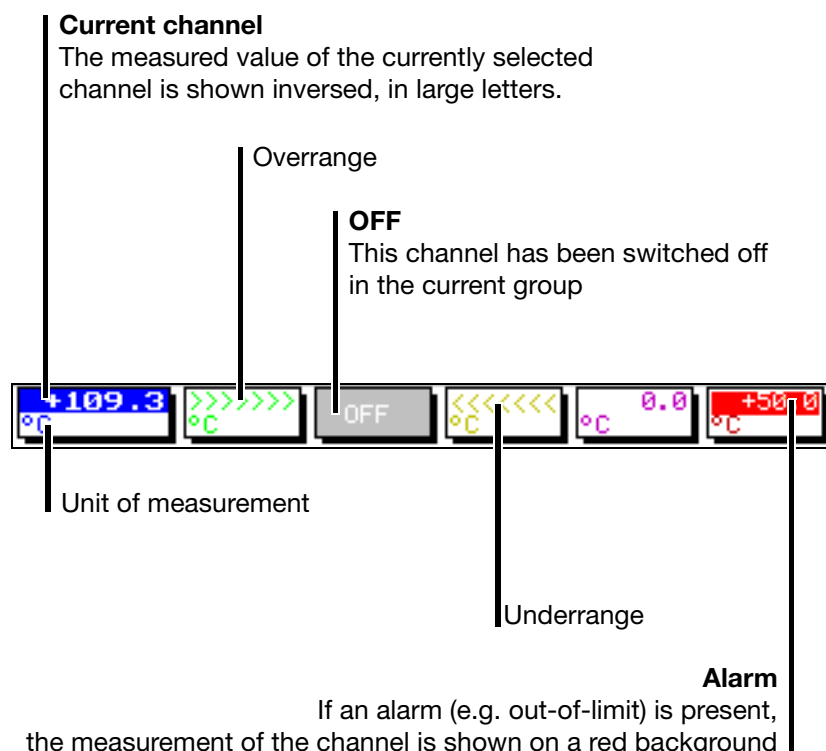

## 2 Instrument description

---

### 2.3 Analog inputs

#### Internal analog inputs

The recorder can internally be equipped with 6 or 12 analog inputs.

When configuring the analog inputs (Chapter 4.2 “Table of configuration parameters”), these are designated **analog input 1 – 12**.

In addition to the internal analog inputs, external analog inputs can also be connected to the recorder.

#### External analog inputs

External analog inputs can be connected to the recorder in two different ways.

##### **Serial interface (Modbus) / Ethernet interface**

The measured values of the external inputs can also be transmitted to the recorder via the two interfaces. In this case, there is no need for either the mTRON modules, or the extra code “LON interface”. The recorder operates in the slave mode, the external device must be the Modbus master .

When configuring the external analog inputs (Chapter 4.2 “Table of configuration parameters”), these are designated **External input 1 – 36**.

Further information on using the serial interface is provided in the Interface Description 9499-040-76311.

##### **PROFIBUS-DP**

This requires the PROFIBUS-DP interface, which is available as an extra.

When configuring the external analog inputs (Chapter 4.2 “Table of configuration parameters”), these are designated **External input 1 – 36**.

Further information on using the PROFIBUS-DP interface can be found in the Interface Description 9499-040-76511.

### 2.4 Digital signals

#### Signal types

In addition to the seven logic inputs, digital signals also include those generated by the instrument itself:



Digital signal	Description
Logic input 1 – 7	Seven logic inputs present in hardware (extra code)
Alarm group 1 – 6	OR combination of all limit infringements on the channels of a group
Combination alarm	OR combination of all group alarms
Logged in	The signal is set when a user is logged in.
Error	Alarm when the battery is empty, or the time has to be set. ⇒ Chapter 3.7 “Device info”
Modbus flag	Control flag which can be activated through the serial interface.
External input 1 – 6	External inputs which can be programmed via the serial interface.
CF plugged in	The signal is set when a CompactFlash memory card is inserted in the recorder.
Stolen CF	The signal is set when the CompactFlash memory card is removed and no user is logged in.
Int. mem. alarm/CF	The alarm is triggered when the available backup memory has fallen below a certain value (configurable). The signal should only be evaluated if the measurement data are read out via the external CompactFlash memory card. ⇒ See “(memory display)” on page 69.
Int. mem. alarm/ser.	The alarm is triggered when the available backup memory has fallen below a certain value (configurable). The signal should only be evaluated if the measurement data are read out through the interface. ⇒ See “(memory display)” on page 69.
Mem. al. CF card	The alarm is triggered when the available memory of the external CompactFlash memory card has fallen below a certain value. ⇒ Chapter 3.6 “CompactFlash card”

## 2 Instrument description

---

### Display

Each of the digital signals can be assigned to a digital channel within a group. They are represented by various diagrams on the screen:

Diagram	Representation
Group manager	On/off represented as switch:  
Horizontal diagram	Representation as a record of time: 
Bar graph	On/off represented as switch
Numerical representation	On/off represented as switch

### Outputs

The digital signals can be used to operate the five relays and the open-collector output. The action can be configured as break (n.c.) or make (n.o.) contact (*Configuration* → *Outputs*).

### Counters

The digital signals can be configured as control signals for counters under *Configuration* → *Control functions* → *Counters* (⇒ Chapter 4 “Configuration parameters”). If a counter text is configured, it is possible, for example, to count when and how often a group alarm has been triggered.

### External texts

External texts can be arranged through the seven logic inputs or the 6 external inputs. Either a *standard text* or one of the 146 definable texts can be used. The instrument automatically supplements the texts in order to distinguish between the appearance and disappearance of the signal. External texts are configured on the instrument under *Control functions*.

⇒ Chapter 3.5 “Event list”

### External report/batches

Start and end of the external report, as well as of the batch report, are controlled through one of the digital signals. The external report and, if required, the batch report are run from the instant at which the control signal becomes active. It is continued until the *control signal* becomes inactive again. The control signal is selected through the parameter *Configuration* → *Report/batches* → *Ext.report/batches* → *Control signal*.

## 2 Instrument description

---

**Event operation** The digital signals can be used to activate event operation. In event operation, the measurements are stored with a storage cycle that is different from normal operation.

**Example** When the available internal memory (during read-out through the CompactFlash memory card) falls below 1Mbyte, the storage cycle of the measurements for group 1 should be set to 20sec.

The following have to be configured:

Parameter	Value/setting
Configuration → Device data → Storage alarm → Int.mem./read-out via CF	1MB
Configuration → Group config. → Group 1 → Event operation → Control signal	Int. mem. al./CF
Configuration → Group config. → Group 1 → Event operation → Storage cycle	20[s]

## 2 Instrument description

---

### 2.5 Counters

The recorder has two internal counters, which can count 10,000 steps.

- Control signal** At the configuration level, the following are configured under *Configuration* → *Control functions* → *Counters* → *Counter 1 – 2*
- the *control signal*,
  - the *start value*,
  - the *count direction*
  - and the *text* for the event list.
- For possible control signals, please refer to Chapter 2.4 “Digital signals”.
- Start value** The start value can be input anywhere between -99.999 and +99.999. For instance, it can be reset to “0”!
- Counting direction** Counting can take place upwards or downwards.
- Text** The text for entries in the event list are configured through the setup program, or from the keys of the instrument. The current count is automatically appended as supplementary text.
- ⇒ Chapter 3.5 “Event list”
- Representation** Like the analog channels, the counters are shown as curves in the diagram. For this to take place, the counter must be assigned as input signal to an analog channel in the group configuration.
- The numerical range to be shown (10,000 steps max.) is configured through the parameters *Configuration* → *Analog inputs* → *Counter 1 – 2* → *Scaling start* and *Scaling end*.

### 2.6 Integrator

In addition to minimum, maximum and average value of an (analog) channel in a group, the reports can include an integrator.

#### Activating the integrator

An integrator time base has to be specified at the configuration level under *Configuration* → *Analog inputs* → *Analog input 1 – 12* → *Additional parameters*, or *Configuration* → *Analog inputs* → *External input 1 – 36* → *Additional parameters*. If no time base is given (*Off*), the indication of the integrator in the reports is suppressed.

The integrator can be used to determine a total flow volume or a liquid level, for instance, and to present it in the diagram.

#### Example

A sensor at analog input 1 provides a signal that is proportional to the flow rate ( $\text{m}^3/\text{h}$ ). The volume ( $\text{m}^3$ ) which has passed through is to be measured using the integrator.

The following settings are required:

Parameter	Value/selection	Description
Configuration → Analog inputs → Analog input 1 → Additional parameters → Unit	$\text{m}^3/\text{h}$	Sensor signal proportional to the flow rate in $\text{m}^3/\text{h}$
Configuration → Analog inputs → Analog input 1 → Additional parameters → Integr. time base	Hour	The flow is measured in $\text{m}^3/\text{hour}$ (h).
Configuration → Analog inputs → Analog input 1 → Additional parameters → Integr. unit	$\text{m}^3$	In the reports, the volume which has passed through is indicated in $\text{m}^3$ . The maximum integrator value is 99999.

## 2 Instrument description

---

### 2.7 Operating modes

**3 operating modes** The instrument has three operating modes:

- normal operation
- timed operation
- event operation

The following settings can, among others, be made for each of the three operating modes:

- stored value
- storage cycle

**Stored value** The stored value determines whether the average/minimum/maximum value of the time interval between two storage cycles or the instantaneous value is stored.

**Storage cycle** The storage cycle determines the interval between two stored values. The diagram speed corresponds to the storage cycle, which means that with a storage cycle of 5sec, for example, the stored value is entered in the diagram every 5sec.

**Normal operation** Normal operation is active whenever event or timed operation is not active.

**Timed operation** For timed operation, a period of time can be defined (up to 24 hrs) within which a specific stored value and a specific storage cycle are active.

**Event operation** Event operation is active as long as its control signal (⇒ page 80) is active. Event operation can be used, for example, to shorten the storage cycle when a combination alarm is present.

**Priority** The respective priorities of the operating modes are allocated as follows:

Operating mode	Priority
Normal operation	3 (lowest)
Timed operation	2
Event operation	1 (highest)

**Active operating mode** The active operating mode is shown in the horizontal and vertical diagrams by the background color of the display for the diagram speed:

Operating mode	Color
Normal operation	gray
Timed operation	blue
Event operation	orange

- ⇒ Chapter 3.2.1 “Vertical diagram”  
Chapter 3.2.2 “Horizontal diagram”



### 2.8 Storing data

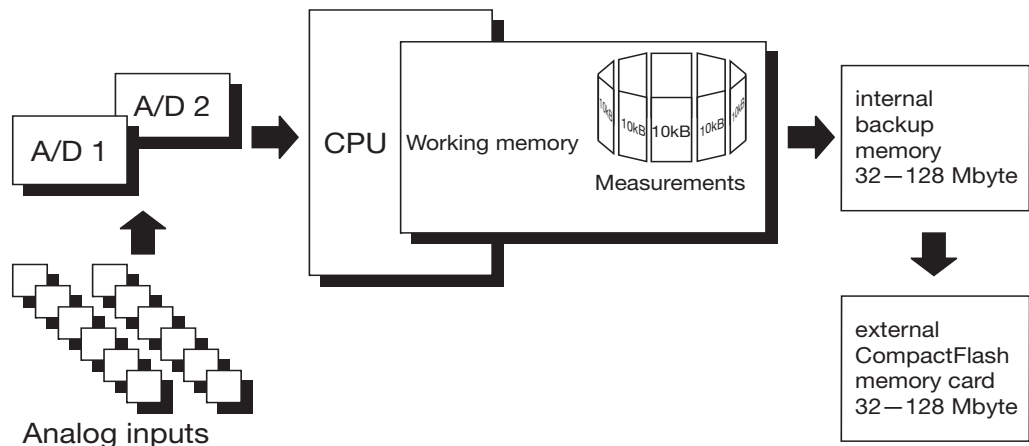

#### Recording capacity

- working memory (RAM): approx. 350,000 measurements
- internal backup memory, depending on the memory size that was ordered
- external CompactFlash card, depending on the memory size that was ordered

#### Storage on external CompactFlash memory card

The recorder saves the measurement data of the internal backup memory automatically to the external CompactFlash memory card. Data storage begins after insertion of the card.

The “CompactFlash card” menu provides additional functions for copying data to the external memory card.

⇒ Chapter 3.6 “CompactFlash card”

#### Storage cycle

Different storage cycles, ranging from 125msec to 32767sec can be configured for normal, event and timed operation under “group configuration”.

The storage cycle determines the time interval for measurement storage.

#### Stored value

Under this parameter, the value to be stored (average, minimum or maximum value of the last storage period or instantaneous value) is configured separately for normal, event and timed operation.

#### Recording format

Data are recorded encoded in a proprietary, tamper-proof format.

#### Recording duration

The recording duration depends on various factors:

- number of analog and digital channels to be recorded
- storage cycle
- number of events in the event list
- number of reports running

## 2 Instrument description

---

**Optimization of recording duration**      The recording duration can be optimized by process-oriented selection of the storage cycle.

In normal operation (no error, no alarm, ...) a storage cycle that is as long as possible (e.g. 60sec, 180sec, ...) should be selected, depending on the particular application.

In the event of an alarm or error, the storage cycle can be shortened via event operation, with the effect that the measurement data are recorded with a high time resolution.

### 2.9 Reading out data

In addition to automatic read-out via the external CompactFlash memory card, measurement data can also be read out through the serial interface or the Ethernet interface.

Both read-out options (card/interface) work in parallel. For this reason, there are also two “digital signals”, which indicate when the available storage space has fallen below a certain configurable value.

#### **Memory alarm**

The following limits can be configured at the configuration level:

*Configuration* → *Device data* → *Memory alarm* → *Int.mem./ser.read-out*  
*Configuration* → *Device data* → *Memory alarm* → *Int.mem./read-out via CF*  
*Configuration* → *Device data* → *Memory alarm* → *CF card (external)*

The parameter *Parameterization* → *Memory display* can be used to determine which storage space display is shown in the status line.

For further information, please refer to:

- ⇒ Chapter 2.8 “Storing data”
- Chapter 2.4 “Digital signals”
- Chapter 3.3 “Parameterization” (page 53)
- Chapter 4 “Configuration parameters” (page 69 and page 72)

#### **Read-out via interface**

Please use the PC software PCC to read out measurement data via the serial or the Ethernet interface. The software has been developed especially for the paperless recorder.

- ⇒ Please refer to the Operating Manual 9499-040-76711 for further information.

### 2.10 Evaluating data

Please use the PC Evaluation Software (PCA3000) for evaluating the data on the PC. The software has been developed especially for the paperless recorder.

- ⇒ Please refer to the Operating Manual 9499-040-76611 for further information.

## 3 Operation and visualization

---

After starting up the paperless recorder by switching on the supply (power ON), you will see the start logo.

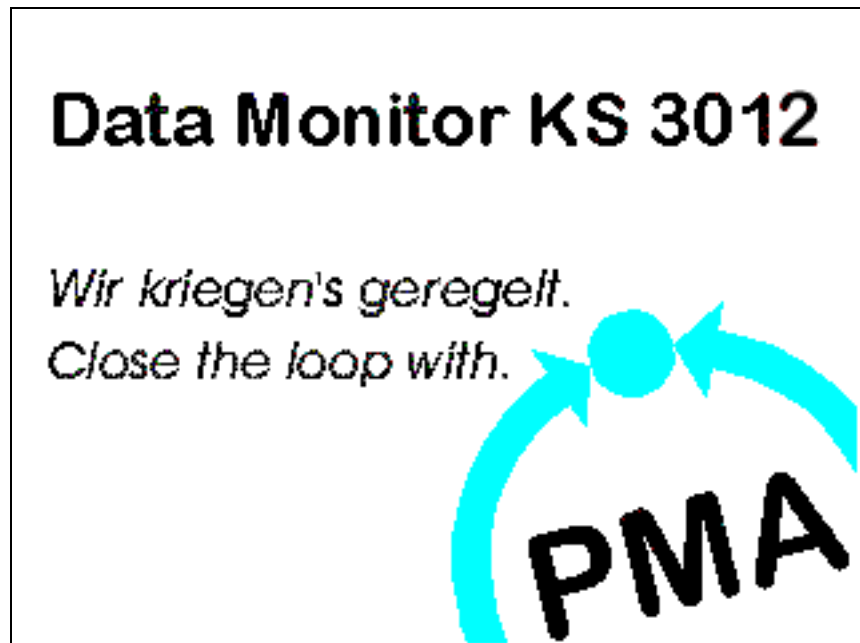

During screen build-up, the recorder is initialized with the data of the last configuration.



After the initialization phase, the view that was last selected at the visualization level is shown, provided that it was active at the time when the instrument was switched off (power OFF).

If this is not the case, the start menu is displayed.

# 3 Operation and visualization

## 3.1 Start menu

### 3.1.1 Overview

The start menu is the central point from which the various instrument levels branch out.

The following levels are available:

- visualization,
- parameterization
- configuration
- event list,
- CompactFlash card and
- device info

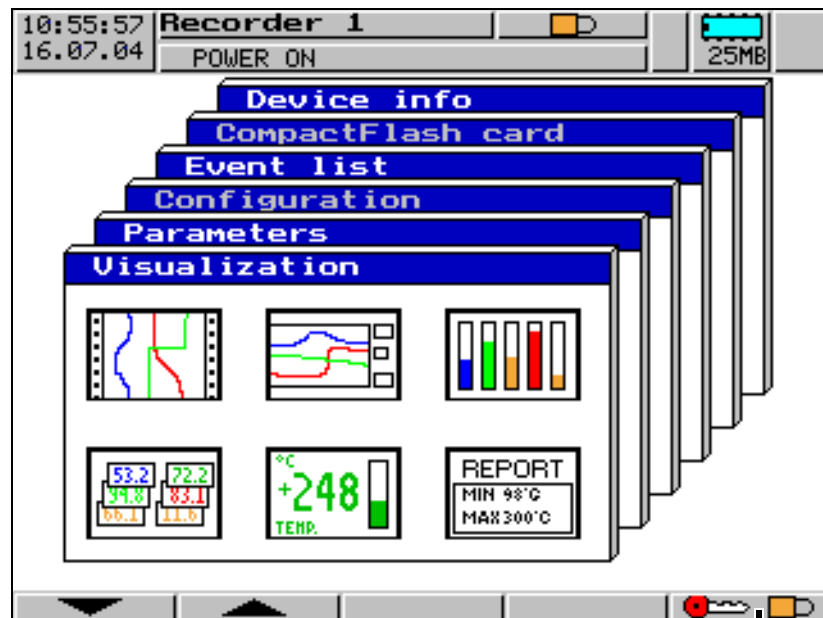

Log in and log off

- \* Select the required level
- \* Enter selection with **ENTER**

The start menu is displayed:

- after pressing the **MENU** key<sup>1</sup>
- after (repeatedly) pressing the **EXIT** key

1. Not from the configuration level, if a parameter has already been modified there.

## 3 Operation and visualization

### 3.1.2 Logging in and logging off

Logging in and logging off is one of the most important functions of the recorder. Without valid log-in or authorization, the menus “Configuration” and “CompactFlash card”, for example, will be inhibited..



- \* Call the “Log-in and log-off” function, and the following menu is started automatically:



- \* Select the required function
- \* Enter selection with **ENTER**

The following functions are available in the menu:

- log in,
- log off (only if logged in) and
- alter password
- \* Select the desired function und press **ENTER**.

#### Standard (default) users



The recorder is delivered ex-factory with an internal user list which comprises two users.

User 1: Master Password: only **ENTER** key

User 2: User Password: 0

Both user names as well as their passwords and rights can be altered and transferred to the instrument through the PC Setup software.

⇒ Chapter 6 “Rights”

### 3 Operation and visualization

---

#### Logging in

- \* Select ID (user name) and confirm with **[ENTER]**.



- \* Enter password via softkeys.



- \* Conclude password entry by pressing the **[ENTER]** key.

This position shows  
the logged-in user

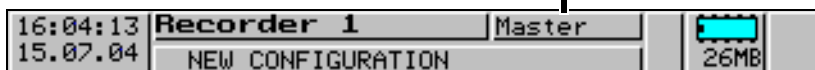

An error message is output for wrong entries.  
Please confirm the message by pressing any key, then repeat  
entry.

## 3 Operation and visualization

### Logging off

- \* Select the “Log-off” function.

The user who is currently logged in is shown on the screen.



- \* Please press `ENTER` to log off.

You are logged off now.



Wrong entries will produce an error message. Confirm the message with `EXIT` and repeat entry.

### 3 Operation and visualization

---

#### Altering the password

- \* Select the function “alter password” and press the **ENTER** key.



- \* From the list, select the user who the password has to be altered for, and confirm with **ENTER**.
- \* Enter the current password (conclude with **ENTER**).
- \* Enter the new password (conclude with **ENTER**).

The new password is entered as described in Chapter 3.8 “Text entry”.

- \* Enter the new password once more (via the softkeys).  
Conclude entry with **ENTER**.

If the entry was free from errors, then the new password is active now.



Wrong entries will produce an error message.  
Confirm the message with **EXIT** and repeat entry.



# 3 Operation and visualization

## 3.2 Visualization

**Start menu → Visualization** After selecting the level *Start menu → Visualization*, the group manager appears.

**Group manager** The instrument manages six visualization groups of measurement inputs. Each group can consist of up to six analog and three digital channels. Operation within the visualization level is always group-oriented.

### Group window

The current analog and digital measurements, as well as the channel name, are displayed here.

The group name is shown on a red background in the window title if an alarm is present within the group. The measurement of the channel which triggered the alarm is also shown on a red background.

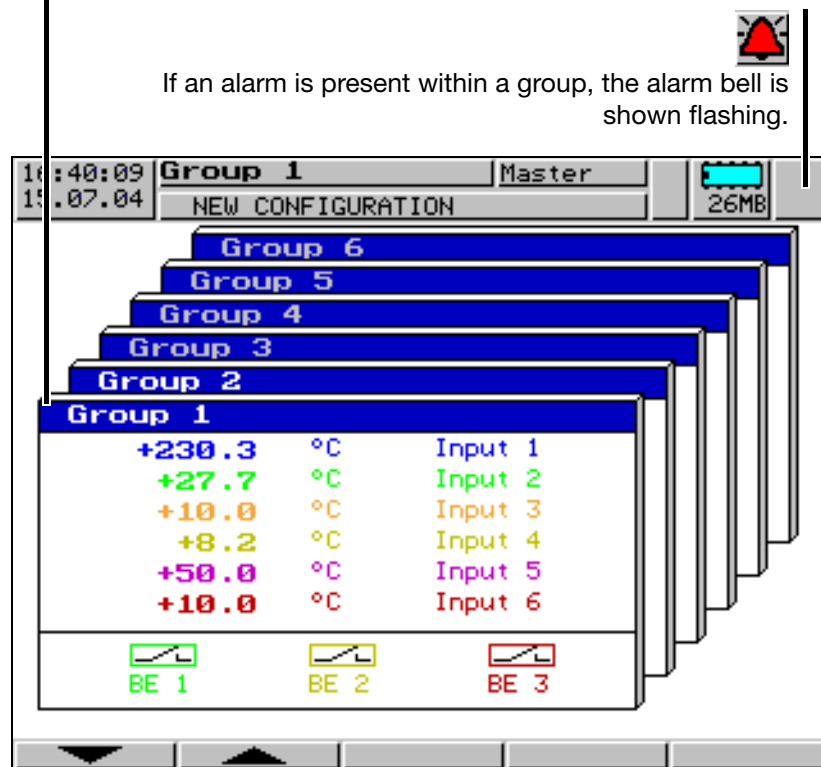

\* Select group



Confirmation of a group with `[ENTER]`, is followed by a switch to vertical diagram representation.

# 3 Operation and visualization

## 3.2.1 Vertical diagram

Vertical diagram representation can be accessed from the group manager (⇒ page 33), after a group has been selected:

- present measurements of the analog inputs of the group
- measurement on a red background ⇒ out of limit

Unit of measurement

Scaling start of the selected channel

Lower limit index of the selected channel (no display when alarm is off)

Underrange on channel 3

Scaling end of the selected channel

Upper limit index (no display when alarm is off)

Present diagram speed

Background color:  
gray = normal operation,  
blue = timed operation,  
orange = event operation

16:25:38 Group 1 26MB

15:17:04 Gr1 chan. 1 HighAlarm OFF

+27.7 °C

+8.2 °C

+50.3 °C

-200.0 Input 1 7.5s/div +850.0

15:20:00

15:19:00

15:18:00

(CH+) ↻ ⏪ ⏩

Change to the previous/next visualization

Channel name of the selected channel

Evaluation of the stored measurement data

Switch to the next active group

Select next channel



# 3 Operation and visualization

## 3.2.3 Evaluation of the stored measurement data



It is possible to evaluate the measurement data of a group if the status of the group (*Group status*) has been configured to *Displ.+store*.

### History



Using this function, all measurement data of the internal RAM (approx. 350,000 measurement data for all groups) can be displayed and evaluated.

Evaluation of the measurement data can be carried out in the horizontal and vertical diagrams. Since the same principle applies to both representation types, the example describes the vertical diagram.

The softkey function changes during evaluation and, in addition, the current zoom factor and cursor position (date and time) are displayed.

Older data from the internal backup memory can only be evaluated after data transmission using the PC Evaluation Software (PCA3000).

### Scroll operation

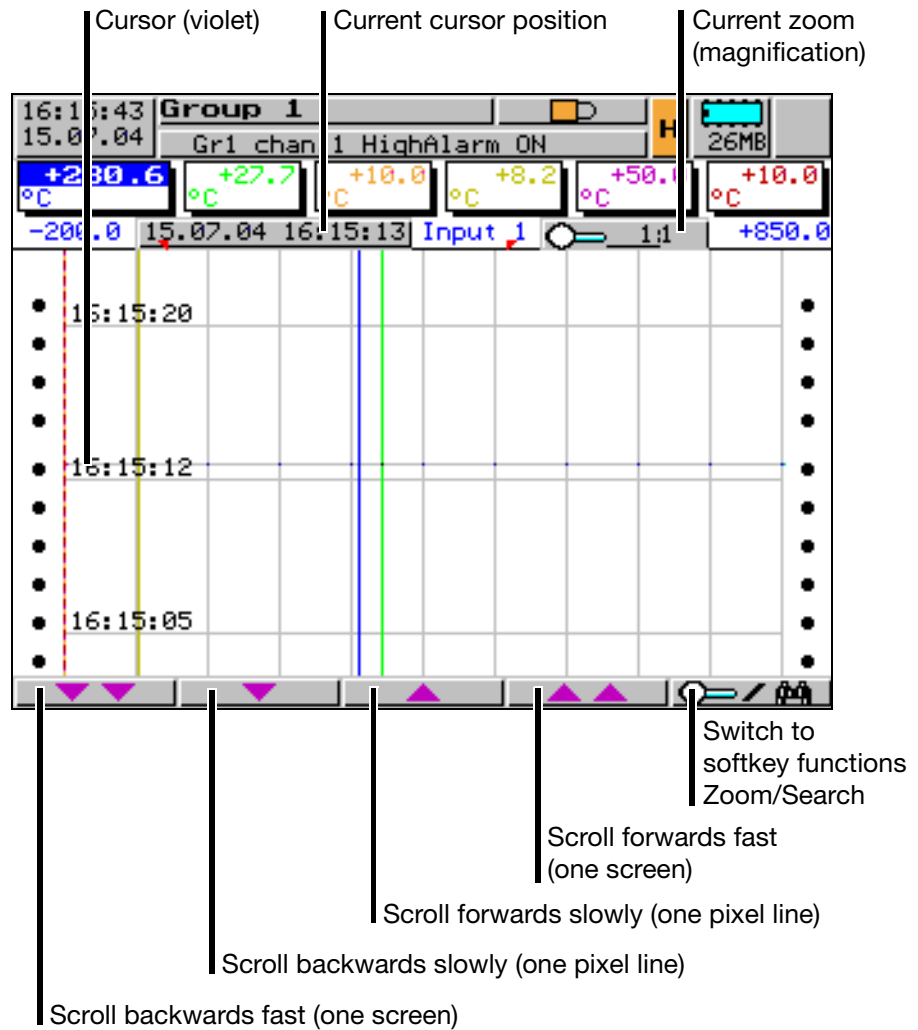

Using these softkeys, the measurement data display can be scrolled (shifted) on the screen within the measurement data stored in the SRAM.

## 3 Operation and visualization

### Zoom

If the zoom factor has to be adjusted, or specific values have to be searched, then it is necessary to switch the softkey functions.

\* Press  softkey

The degree of compression of the measurement data on the screen is given as a ratio in steps (1:1, 1:2, 1:5, 1:10, 1:20, 1:50 and 1:100).

For instance, 1:100 means that 1 screen pixel corresponds to 100 measurements.

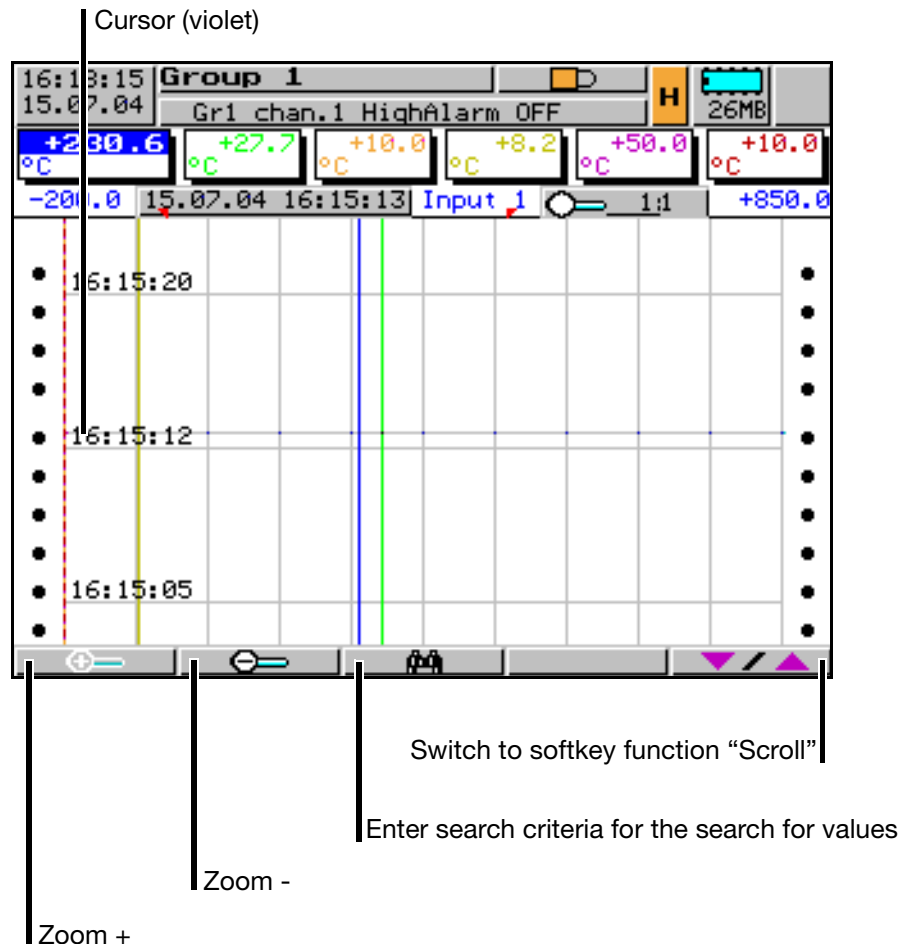

### Search criteria



Several search criteria can be employed in the search for values:

- Limitation to a time period within the stored measurement data.  
If no comparison operator is defined, a search is made for the set start time.  
The measurements are shown, as far as they are available.
- Comparison of the measurements of a channel against a comparison value.  
If the search has been successful, the position is shown in the center of the screen, below the cursor.
- Combination (AND, OR) of the measurement check on a channel with a second measurement check on the same or another channel.

### 3 Operation and visualization

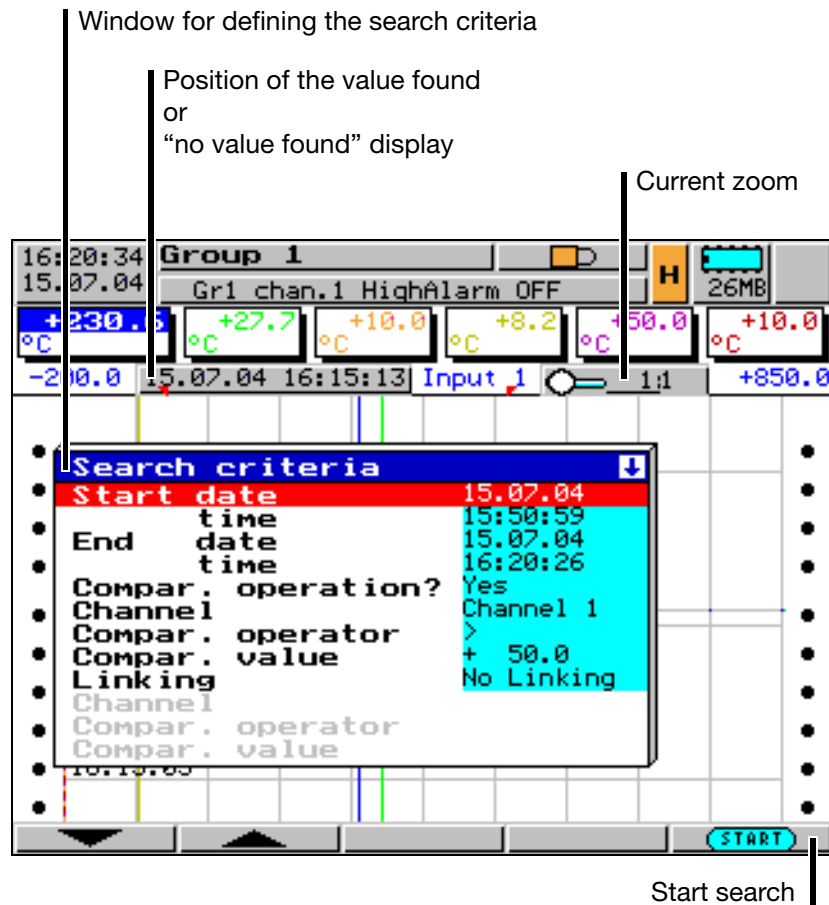

The example above shows the search for the first occurrence of a measurement >50 on channel 1 on the 14.04.03 within the period from 15:16:48 to 15:44:24.

#### Search result

Two results are possible:

- no (further) value was found (display: "no value found")
- a value which fulfils the search criteria was found

#### "no value found"

If no (further) value was found, the text "no value found" is shown in the cursor position field.

#### Value found

If a (further) value was found, the measurement representation is shifted in such a way as to display the value that was found in the center of the displayed range. The cursor (violet line) is positioned there.

#### Continue search

If a (further) value was found which meets the search criteria, the softkey can be used to search for further values until no further value is found.



# 3 Operation and visualization

## 3.2.4 Bar graph representation

In bar graph representation, the latest measurements of the group are shown as bar graphs, in addition to the numerical display.

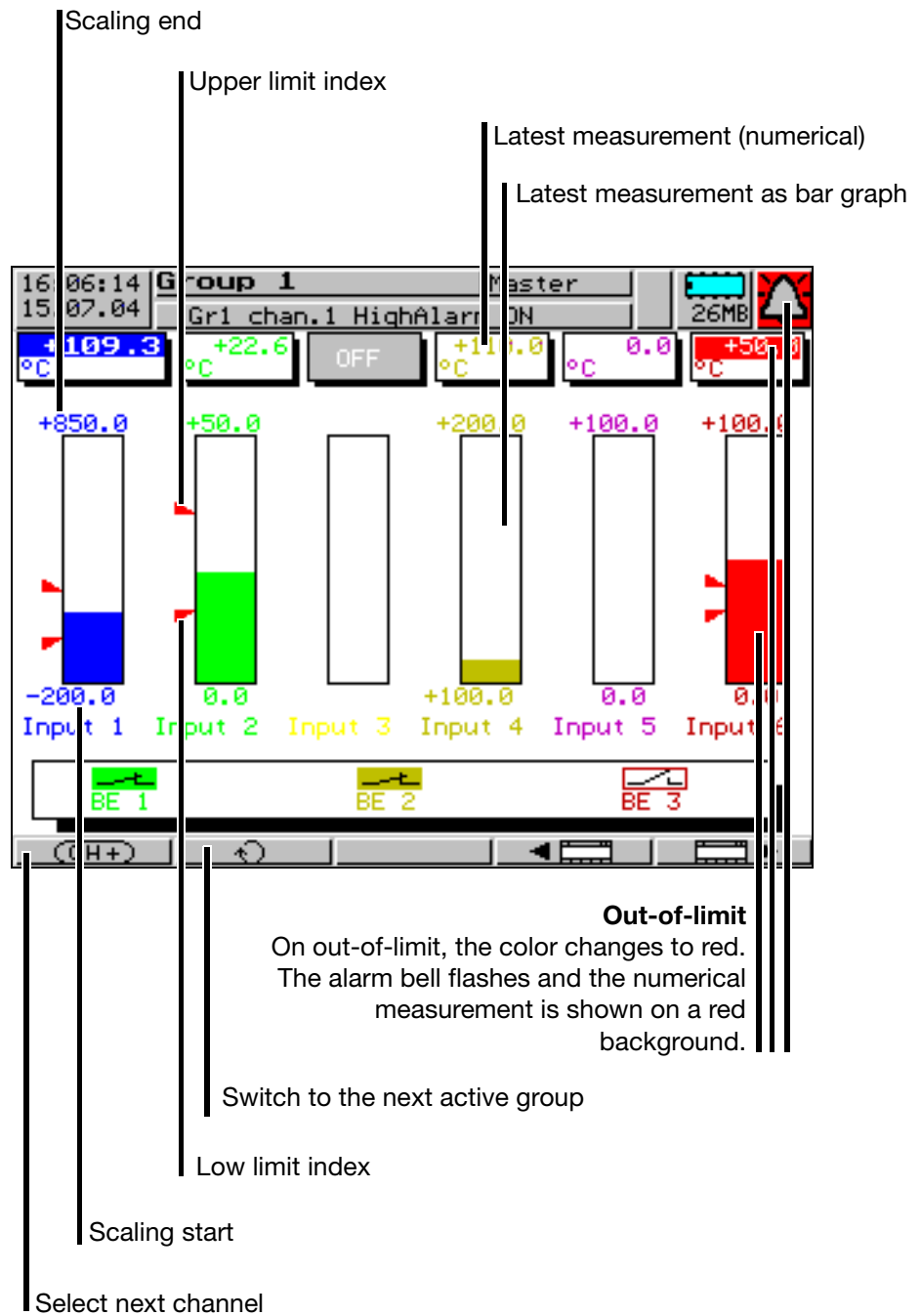

# 3 Operation and visualization

## 3.2.5 Numerical representation

In numerical representation, the currently measured values of a group are shown in large characters. The exact measurements can then be read easily from a distance of several meters.

The window of the selected channel is in the foreground so that the channel name, description and unit can be seen.

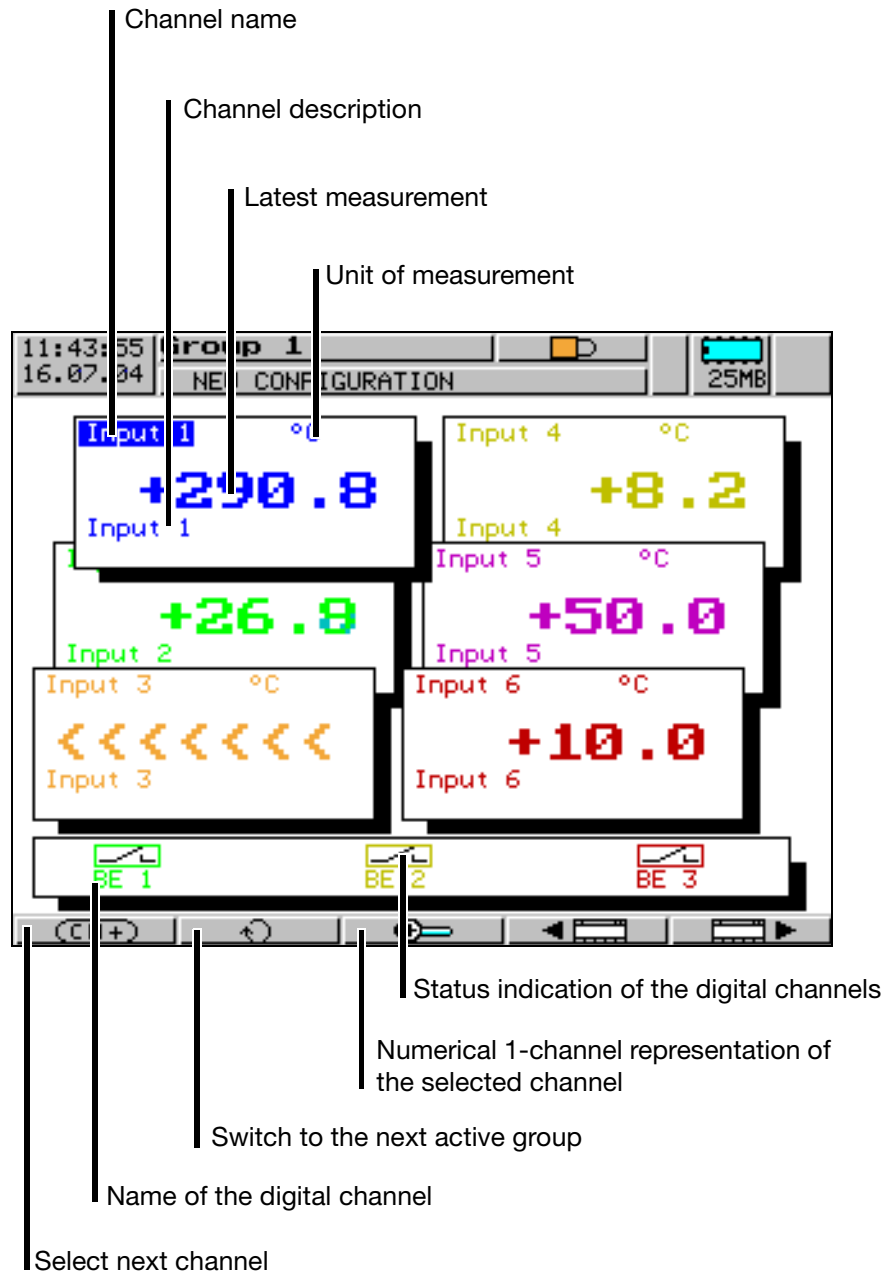



# 3 Operation and visualization

## 3.2.6 Numerical 1-channel representation

The numerical 1-channel representation is called up from the numerical representation, via the softkey .

In the numerical 1-channel representation, the latest measurement of a channel is shown in large letters both numerically and as a bar graph.

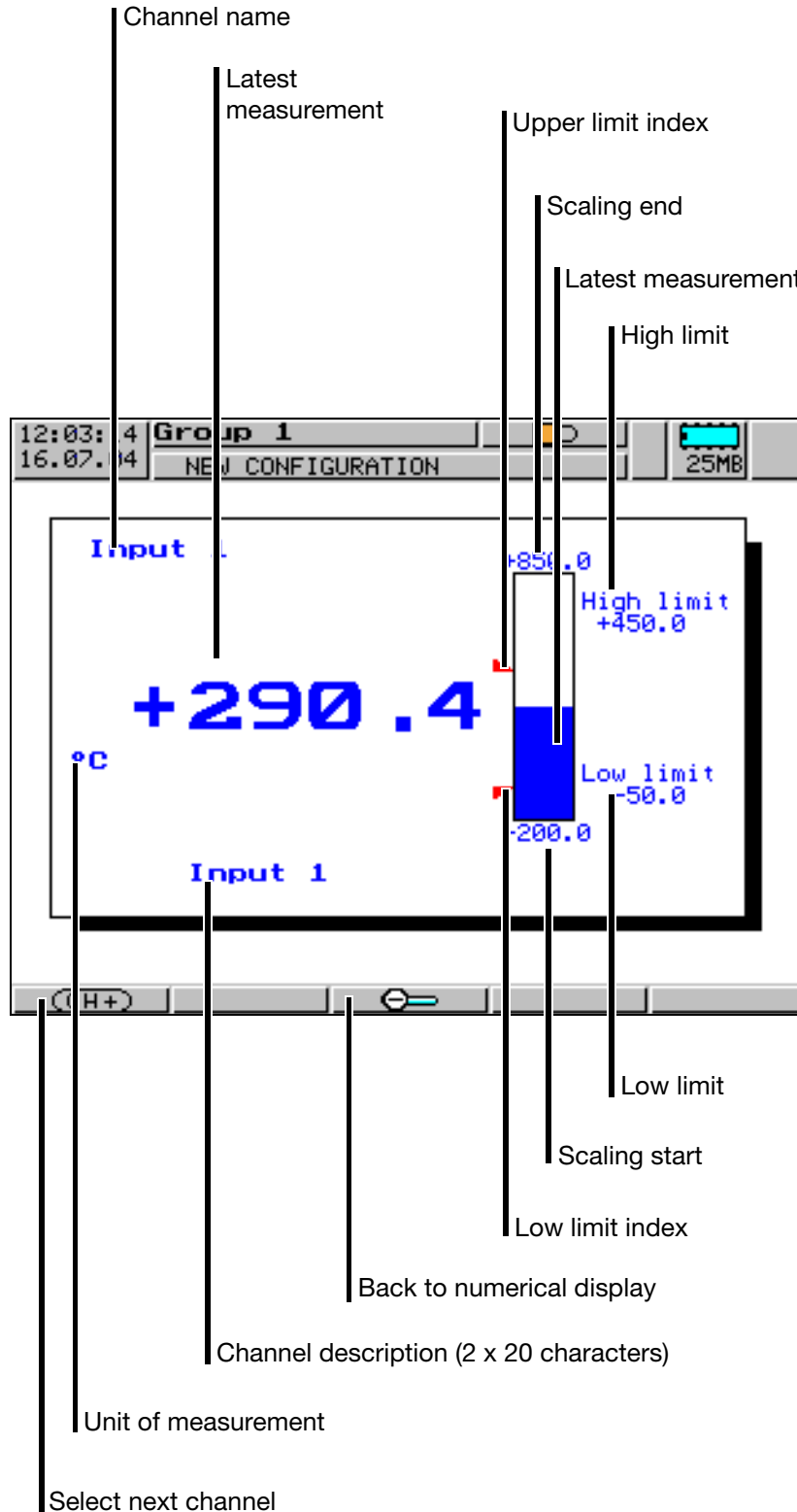

# 3 Operation and visualization

## 3.2.7 Reports

**Definition** A report is a set of statistics covering a specific period of time, which contains the minimum, maximum, average and, possibly, the integration value.

**Types** The recorder can run five different types of report:

- periodic report  
(a report of a specific length of time, which is repeated periodically)
- external report/batches  
(a report which is activated by a control signal, e. g. logic input, alarm, fault, memory alarm, ...).
- daily report
- monthly report
- annual report

**Synchronization time** All reports, apart from the external report, will be repeated according to a configurable synchronization time (⇒ page 85).

**Current/completed report** For each type of report, the currently running and the latest concluded report can be displayed.  
⇒ Chapter 2.6 “Integrator”

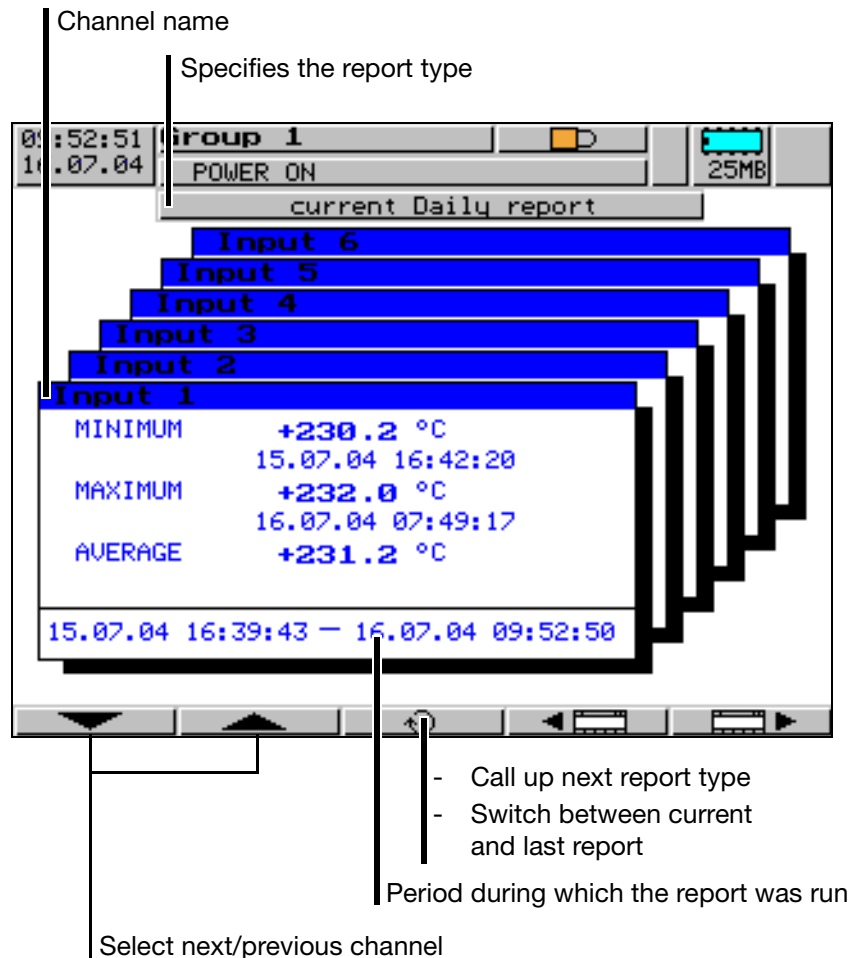

### 3.2.8 Batch reports

Batch reporting enables the creation of a flexible form to describe a batch process within the recorder. It can only be run parallel to an external report and is active when the parameter *Configuration* → *Report/Batches* → *Ext.Report/Batches* → *Status* has been configured to “E.R.+batches”.

Batch reporting (external report) can be controlled through one of the digital signals. The selection is made using the parameter *Configuration* → *Report/Batches* → *Ext.Report/Batches* → *Control signal*.

For additional information on the digital signals, see

⇒ Chapter 2.4 “Digital signals”

Two different screen representations are available for batch reporting:

- current batch report and
- completed batch report



The batch reporting function is described more fully on the following pages.

The batch report shown only serves as an example.

It can be adapted to match your specific requirements through reconfiguration.

### 3 Operation and visualization

#### General



The screen arrangement is identical for both batch reports. It consists of 10 lines on the screen and 2 columns.

The left column “Text field (1)” contains text which describes the text in the right column “Text fields (2), (3) and (4)”. Text field (2) is used for “general batch texts”, text field (3) for the designation of the “batch number” and text field (4) defines the “time report”.

The table below describes by which means the individual text fields can be configured.

Text field	Setup program	Text editor	automatic	Serial interface	Ethernet
(1)	yes	yes		yes	yes
(2)	yes	yes		yes	yes
(3)		yes	yes		
(4)			yes		



Each of the 10 lines is freely selectable and can be freely positioned.

### 3 Operation and visualization

#### Text field (1)

Text field (1) has to be set up before commissioning the system. Each line consists of a maximum of 15 characters.

Example: Parameter setting for line 1

Parameter for line 1	Parameter setting
<i>Configuration → Report/Batches → Ext.Report/Batches → Batches → Line 1 → Text left column</i>	Program name

#### Text field (2)

Text field (2) “Lines 1 – 6” was pre-assigned during recorder configuration, but can be overwritten as long as the batch is not completed. Each line can hold text with a maximum of 20 characters.



Example: Parameter setting for line 1

Parameter for line 1	Parameter setting
<i>Configuration → Report/Batches → Ext.Report/Batches → Batches → Line 1 → Contents right column</i>	Fixed text
<i>Configuration → Report/Batches → Ext.Report/Batches → Batches → Line 1 → Default text</i>	C/65
<i>Configuration → Report/Batches → Ext.Report/Batches → Batches → Line 1 → Text editable?</i>	Yes

Using the text editor (button ), which is integrated in the recorder, the texts can be altered at a later stage, through the setting “Text editable = Yes”.

Example: Parameter setting for line 5

Parameter for line 5	Parameter setting
<i>Configuration → Report/Batches → Ext.Report/Batches → Batches → Line 5 → Contents right column</i>	Text list
<i>Configuration → Report/Batches → Ext.Report/Batches → Batches → Line 5 → from text No.</i>	90
<i>Configuration → Report/Batches → Ext.Report/Batches → Batches → Line 5 → to text No.</i>	91
<i>Configuration → Report/Batches → Ext.Report/Batches → Batches → Line 5 → Text editable?</i>	Yes
<i>Configuration → Texts → Text 90</i>	Tablets XYZ
<i>Configuration → Texts → Text 91</i>	Tablets 123

The text in line 5 is selected from the internal text list of the recorder by calling up the button  followed by .

### 3 Operation and visualization

Example: Parameter setting for line 6

Parameter for line 6	Parameter setting
<i>Configuration → Report/Batches → Ext.Report/Batches → Batches → Line 6 → Contents right column</i>	Binary-linked text
<i>Configuration → Report/Batches → Ext.Report/Batches → Batches → Line 6 → Binary linking</i>	Logic inp1-2
<i>Configuration → Report/Batches → Ext.Report/Batches → Batches → Line 6 → from text No.</i>	80
<i>Configuration → Report/Batches → Ext.Report/Batches → Batches → Line 6 → Text editable?</i>	Yes
<i>Configuration → Texts → Text 80</i>	normal version
<i>Configuration → Texts → Text 81</i>	heavy version
<i>Configuration → Texts → Text 82</i>	plus version
<i>Configuration → Texts → Text 83</i>	plusC version

The text in line 6 is selected from the internal text list of the recorder by linking the internal logic inputs.

Parameter <i>Configuration ... Binary-linked texts</i>	Number of possible texts
Logic inp1-2	4
Logic inp1-3	8
Logic inp1-4	16
Logic inp1-5	32
Logic inp1-6	64

#### Text field (3)

Text field (3) (line 7) can be written to as long as the batch is not completed. The internal text editor (button ) can be used to input any number of up to 16 digits. After the batch has been completed, the batch number is automatically incremented.

Example: Parameter setting for line 7

Parameter for line 7	Parameter setting
<i>Configuration → Report/Batches → Ext.Report/Batches → Batches → Line 7 → Contents right column</i>	Batch No.

### 3 Operation and visualization

---

**Text field (4)**

Text field (4) is filled automatically by the recorder and cannot be altered.

Example: Parameter setting for line 8

Parameter for line 8	Parameter setting
<i>Configuration → Report/Batches → Ext.Report/Batches → Batches → Line 8 → Contents right column</i>	Batch start

Example: Parameter setting for line 9

Parameter for line 9	Parameter setting
<i>Configuration → Report/Batches → Ext.Report/Batches → Batches → Line 9 → Contents right column</i>	Batch end

Example: Parameter setting for line 10

Parameter for line 10	Parameter setting
<i>Configuration → Report/Batches → Ext.Report/Batches → Batches → Line 10 → Contents right column</i>	Batch duration

# 3 Operation and visualization

**Batch texts** How can something be edited? Here is the summary again:

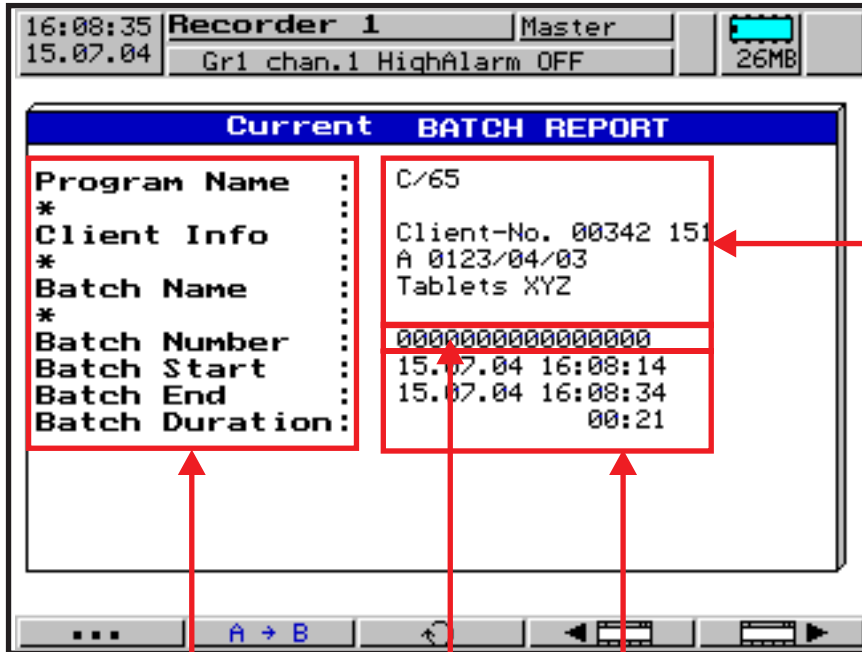

Texts can be edited on the instrument and by using the setup software. They can also be transferred online to an instrument, through the setup software.

- Instrument:**
- configuration
  - report/batches
  - ext. report/batches
  - batches
  - line 1 – 10
  - default text

- Instrument:<sup>1</sup>**
- visualization
  - group 1 – 6
  - current batch report
  - press **A → B**
  - place red bar
  - press **A → B** again<sup>2</sup>
  - edit

- Setup software:**
- report / batches
  - ext. report / batches
  - edit
  - batch report

- Setup software (online):**
- make connection
  - extras
  - write interface texts<sup>3</sup>

Texts can be edited on the instrument and through the setup software.

- Instrument:**
- configuration
  - report/batches
  - ext. report/batches
  - batches
  - line 1 – 10
  - text in left column

- Setup software:**
- report / batches
  - ext. report / batches
  - edit
  - batch report

If batch start/end/duration are used, the lines cannot be edited.

The batch number can only be edited on the instrument.

1. Only available, if the batch parameter “Text editable?” is set to “Yes”.  
 2. According to option, also or .  
 3. Each line has to be activated in the configuration for writing via interface.



### 3 Operation and visualization

**Current batch report**

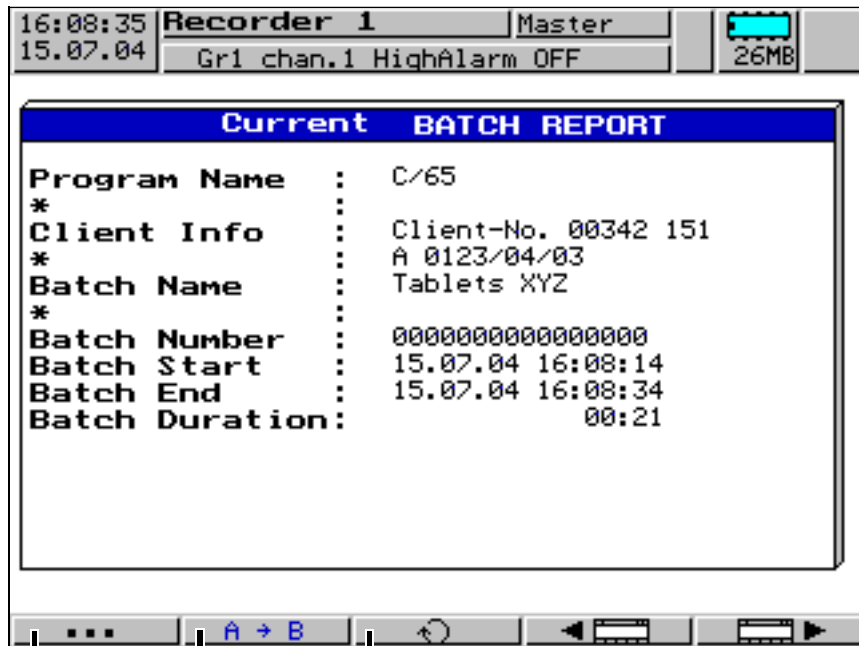

Change to the previous/  
next visualization

Change between "current" and  
last "completed" batch report

Edit all editable parameters in the right column

Switch the four right-hand softkeys to additional functions



Show report data of batch  
report

Show data of batch report as history in  
"horizontal diagram".

Show data of batch report as history in "vertical diagram".

Switch the four right-hand softkeys to original functions



# 3 Operation and visualization

## Completed batch report

The screenshot shows a completed batch report.

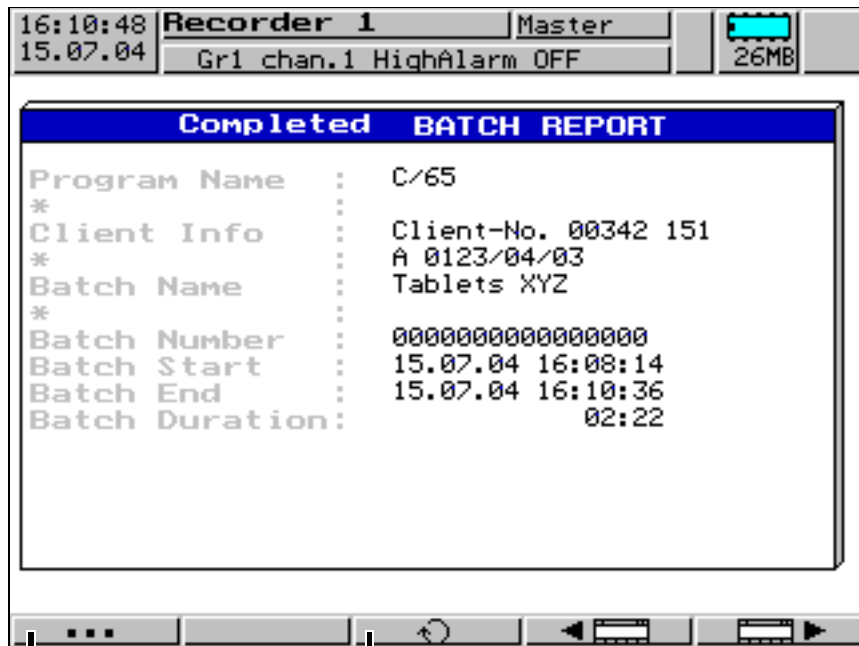

Change to the previous/next visualization

Change between "completed" and "current" batch report

Switch the four right-hand softkeys to additional functions



Show report data of batch report

Show data of batch report as history in "horizontal diagram".

Show data of batch report as history in "vertical diagram".

Switch the four right-hand softkeys to original functions

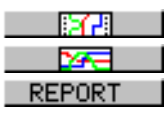

How to operate the "vertical" and "horizontal diagrams" is described in Chapter 3.2.3 "Evaluation of the stored measurement data".

Pressing the **EXIT** key will call up the batch report again.

## 3 Operation and visualization

---

### 3.3 Parameterization



The following can be set at the parameter level:





- contrast,
- speed indication,
- memory display,
- display off (screen saving),
- fine calibration and
- date and time



Depending on the existing user rights, various functions may be inhibited.

⇒ Chapter 6 “Rights”



All parameter are selected using the  and  or  and  buttons.

# 3 Operation and visualization

**Contrast** The contrast of the screen can be set here. This ensures that the screen is always highly legible, even under difficult light conditions.

**Speed indication** Here, “time/div“ or “mm/h” can be selected for the speed display in the vertical and horizontal diagrams.

Example: a diagram speed of 1 h/div corresponds to 22mm/hr.

**Memory display** You can determine the appearance of a part of the status line here.



The following symbols can be set:



Memory display → CF card (external) = always

or

Memory display → CF card (external) = if plugged in

If “CF card (external)” is not set to “always”, there is a further parameter:



Memory display → Internal memory: for = read-out via CF

or

Memory display → Internal memory: for = ser. read-out



⇒ Chapter 2.2 “Operating principle and graphic elements”

**Display off (screen saving)**

Display off → Switch-off event = waiting time

For screen saving, a time between 0 and 32767min can be set here. If no key on the recorder is operated during this time, then the screen goes dark. If 0min is set, then screen saving is deactivated.

Display off → Switch-off event = control signal

Display switch-off is initiated by one of the digital signals. For additional information on the digital signals, see

⇒ Chapter 2.4 “Digital signals”



The power LED blinks during screen saving.

### 3 Operation and visualization

---

**Fine calibration** Using fine calibration, the analog measurements can be calibrated (adjusted). The adjustment is carried out using a linear equation. After selecting the channel, first set the parameter *Fine calibration* → *Calibration status* = ON (active), then enter the parameters for fine calibration.

<i>Actual start value</i>	Start value of the actual line
<i>Target start value</i>	Start value of the target line
<i>Actual end value</i>	End value of actual line
<i>Target end value</i>	End value of target line

Systematic errors, such as those caused by an unsuitable probe mounting, for example, can be compensated through fine calibration.

Example:

A probe provides measurements that cover a temperature range from 200 to 300 °C. It has been installed in a tunnel oven so unfavorably as to always indicate 10°C less than the temperature of the charge. The incorrect measurement can be corrected through fine calibration.

Actual start value	: 200°C
Target start value	: 210°C
Actual end value	: 300°C
Target end value	: 310°C



Performing a fine calibration is handled in the same way as altering the configuration. After fine calibration, the recorder can be reset.



Calibration is de-activated through *Calibration status* = Off.

#### **Date and time**

Here you can set the internal clock of the recorder.



Setting the date and time is treated in the same way as altering the configuration. After setting the date or the time, the recorder is reset.

### 3.4 Configuration

The configuration level can only be called up if the user who is logged in has the right to do so. Rights are administered through the PC Setup software.

#### Window technology

As for the other levels, the principle of configuration is also based on menu-led window technology. Individual menu items can be selected in the windows. The window title describes the contents of the window.

When a menu item has been selected, a further window with new menu items is opened, until the required parameter is finally reached. If several windows are open, the window title assists in orientation.

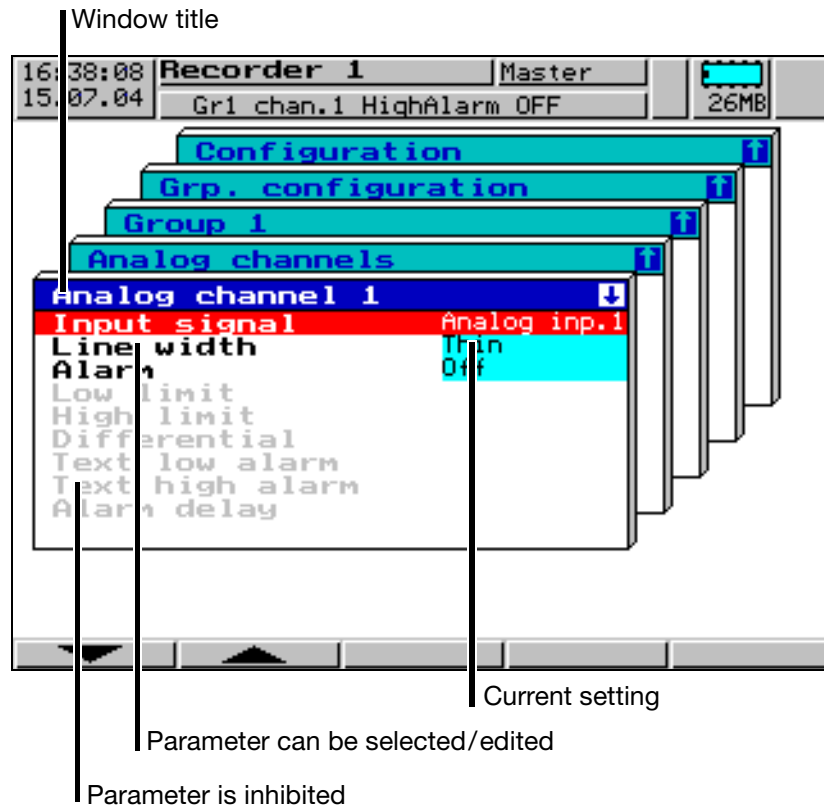

The configuration of the recorder is sub-divided into the following levels:

- device data,
- analog inputs,
- digital signal name,
- group configuration,
- outputs,
- control functions,
- report / batches,
- texts and
- interfaces.

The individual parameters are listed in Chapter 4.2 "Table of configuration parameters".

## 3 Operation and visualization

---

### 3.5 Event list

The tabular event list is concealed behind the menu item:

Different events can initiate texts in the recorder, which are included in the event list. The list is saved to the RAM and the CompactFlash memory card.

#### Events

Events may include:

- alarms triggered by out-of-limit conditions on individual channels,
- external texts triggered through logic inputs,
- message texts received via the serial interface,
- system messages (e.g. power ON/OFF, summer/winter time changeover),
- incrementing/decrementing of an (event) counter (usually triggered through a logic input).

#### Event definition

For all events, except for system messages, it is possible to configure whether:

- the message text is to be included in the event list,
- the instrument-internal standard text
- or one of the texts (see below) is used.

#### Text assignment

The texts (standard texts which include 146 freely definable texts) are assigned to events at the operating level "Configuration" (⇒ Chapter 4 "Configuration parameters").

#### Standard texts

The recorder offers standard texts as listed in the following table:

Standard text	Comment
Gr <sub>x</sub> Chan <sub>y</sub> low alarm ON Gr <sub>x</sub> Chan <sub>y</sub> low alarm OFF Gr <sub>x</sub> Chan <sub>y</sub> high alarm ON Gr <sub>x</sub> Chan <sub>y</sub> high alarm OFF Logic input x ON Logic input x OFF Ext. input x ON Ext. input x OFF	<i>x</i> = group number <i>y</i> = channel number
Power ON Power OFF Data lost Summer time start Summer time end New configuration	
Counter 1: +xxxxx Counter 2: +xxxxx	5 digits plus sign, no decimal point



### 3 Operation and visualization

**Freely definable texts** 146 texts belonging to the group of standard texts can be freely defined, up to a length of 20 characters.

Standard text	Comment
"Text 1 – 146" In the case of logic signals and alarms, the supplementary text "ON" or "OFF" is added automatically, on counters the current count is added.	146 freely definable texts with 20 characters each

**Supplementary text** The recorder automatically supplements the texts by "ON" or "OFF" in order to distinguish between the appearance and disappearance of the signal.

Example:

Standard text	Supplementary text	Entry in event list
Logic input 2	ON	Logic input 2 ON
Logic input 2	OFF	Logic input 2 OFF

**Interface text** A text of up to 20 characters length can be entered in the event list via the serial interface. For further information, please refer to the Interface Description 9499-040-76311.

**Start menu→ Event list** The event list is called up via the start menu:

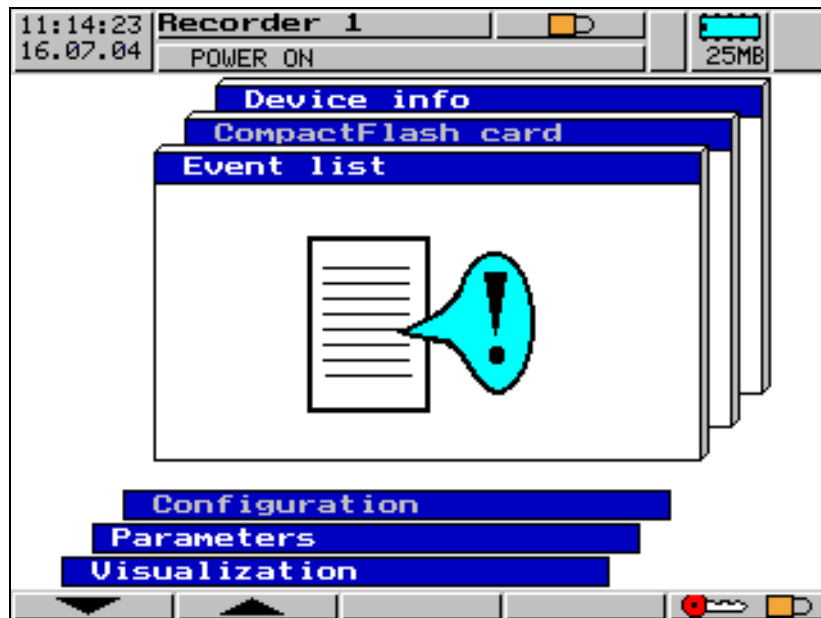

- \* Select operating level *Event list*
- \* Enter selection with **ENTER**

### 3 Operation and visualization

---

#### Event list

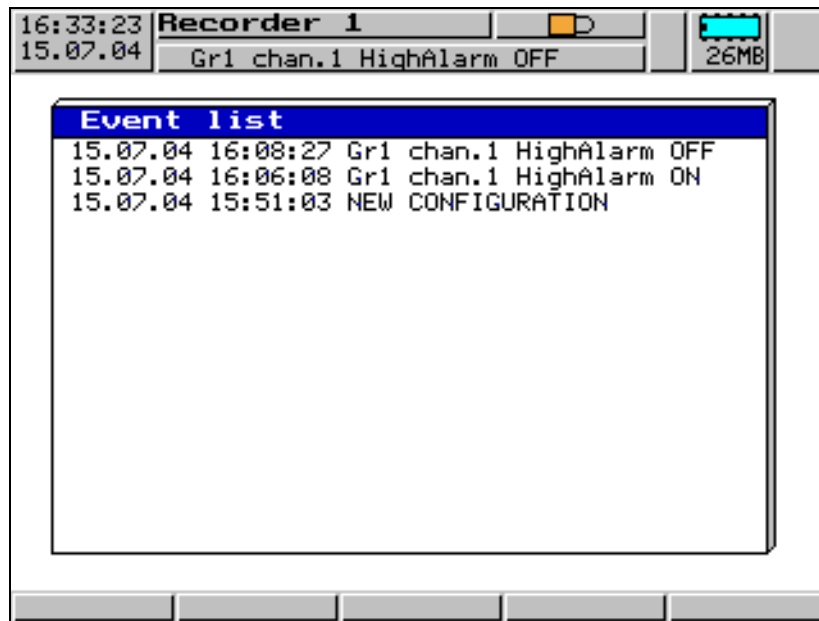

# 3 Operation and visualization

## 3.6 CompactFlash card

The CompactFlash card<sup>1</sup> menu can only be called up if the user who is logged in has the right to do so. Rights are administered through the PC Setup software.

### Automatic storage of measurement data

The data stored in the paperless recorder are automatically saved to the CompactFlash memory card at regular intervals. The PC Evaluation Software reads the data off the memory card and provides convenient functions for evaluation.

The data stored on the external CompactFlash memory card and in the recorder are not deleted when the configuration is altered.

⇒ Additional information about the PC Evaluation Software (PCA3000) can be found in the Operating Manual 9499-040-76611.

### Loading and saving the configuration data

The configuration data can be downloaded from the CompactFlash memory card and saved to the CompactFlash memory card. In addition, this makes it possible to copy a configuration from one instrument to another (or to transmit it from/to the setup software).

A configuration data file can be stored on the CompactFlash memory card. Measurement data or other data already stored on the CompactFlash memory card will not be overwritten during storing.

### Start menu→ CompactFlash card

The menu is called up via the start menu:

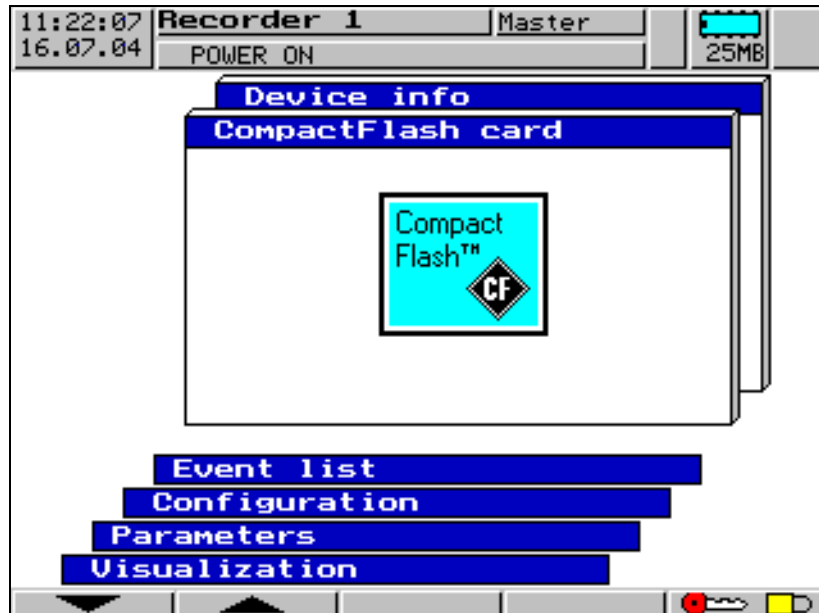

- \* Select operating level *CompactFlash card*
- \* Enter selection with **ENTER**

1. PC Card access made available by CSM FAT File System  
Copyright © 1997-2002 CSM GmbH Filderstadt, Germany

### 3 Operation and visualization

#### CompactFlash card

Measurement data not yet saved are written to the CompactFlash memory card.

All running reports are concluded and written to the CompactFlash memory card, together with the measurement data not yet saved.

All measurement data in the memory (also those which have already been fetched) are written to the CompactFlash memory card.

The configuration data are written to the CompactFlash memory card.

The configuration data are read in from the CompactFlash memory card. The recorder will thus be freshly configured.

The user list is read in from the CompactFlash memory card.

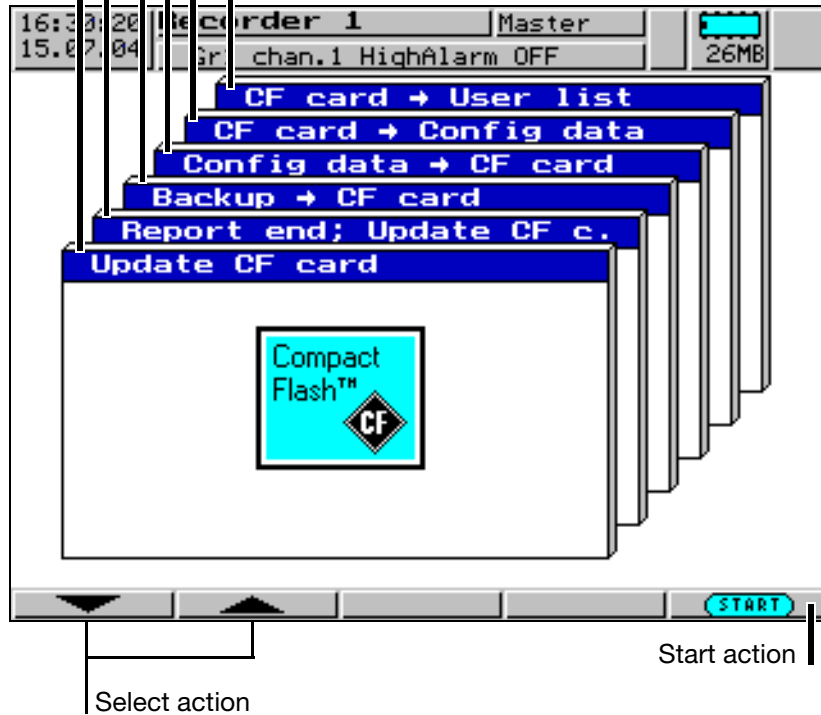

The function *Update -> CF card* reads out data that have not yet been read out. After read-out, the data are marked as read in the recorder.

The function *Backup -> CF card* reads out all the data of the internal memory, also those that have already been read out. After read-out, the data are **not** marked as read in the recorder. This means that they remain available for the function *CF card -> Update*. The function *Backup -> CF card* is therefore ideal for test and maintenance purposes.

### 3 Operation and visualization

#### Status messages

Status messages of the CompactFlash card menu are shown in a separate window in the menu.

- If you use the **EXIT** key to confirm a message, the CompactFlash menu is automatically terminated.
- If you use the **ENTER** key to confirm a message, only the message is deleted, the CompactFlash menu continues to be active.

The following status messages are possible:

Status message	Description
Action successfully completed.	Directly before removing the CompactFlash card from the instrument, it is necessary to call up <i>Update CF card</i> so that all measurement data up to the time of removal are contained on the CompactFlash card. The data not yet stored since the last automatic saving are written.
Action canceled.	This message is shown when accessing the CompactFlash card has been canceled by activating the <b>Esc</b> button.
No card in disk drive!	Access to the CompactFlash card was attempted, even though there is none in the instrument.
Not enough memory available on card!	The CompactFlash card is full. No more data are written.  Remedy: Insert a blank CompactFlash card before the measurement data memory of the recorder is also full. If this is not done, measurement data will be lost.
Card is write-protected!	The inserted CompactFlash card cannot be written to because it is write-protected.
Card is not DOS-formatted!	An error has occurred while writing to the CompactFlash card, because it was wrongly formatted or not formatted at all.  Remedy: Format the CompactFlash card.
General error!	An error has occurred while writing to the CompactFlash card. The CompactFlash card may be faulty.  Remedy: Insert new (DOS-formatted) CompactFlash card.
No config. data on the CompactFlash card found!	You start the function <i>CF card</i> → <i>Config. data</i> and there are no configuration data on the CompactFlash card.  Remedy: Check card on PC and generate data again, if necessary.
No user list on the CompactFlash card found!	You start the function <i>CF card</i> → <i>User list</i> and there is no user list on the CompactFlash card.  Remedy: Check card on PC and generate list again, if necessary.

### 3 Operation and visualization

---

Status message	Description
The user list was not accepted!	You start the function <i>CF card</i> → <i>User list</i> , but the user list could not be accepted for unknown reasons. Remedy: Check card on PC and generate list again, if necessary.
Card is faulty!	The CompactFlash card does not respond. It is probably faulty. Remedy: Reformat card, or use a new one.

# 3 Operation and visualization

## 3.7 Device info



The device info window displays general information about the instrument. It also includes the errors “Battery empty” and “Data lost”. If one of these instrument errors occur, the info symbol flashes in the status line.

Start menu→  
Device info

The device info is called up from the start menu:

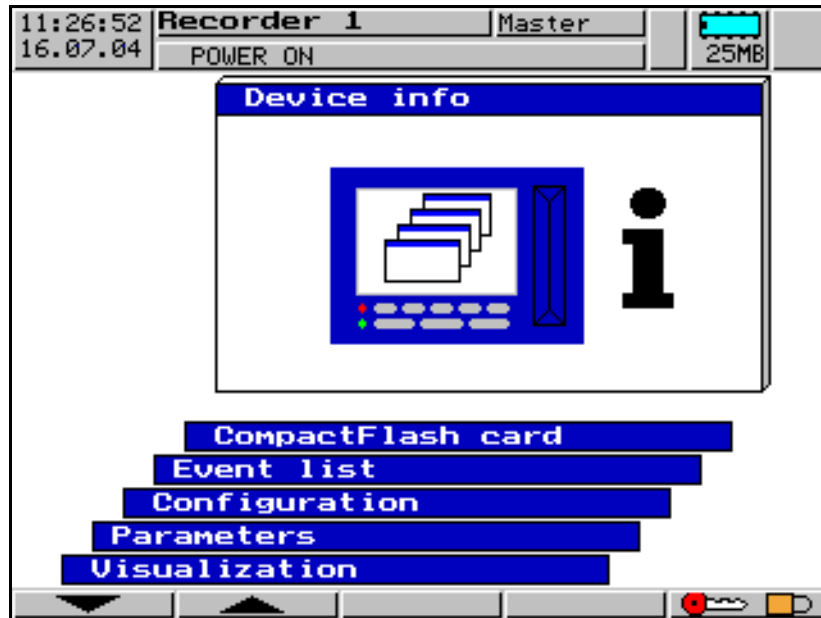

- \* Select operating level *Device info*
- \* Enter selection with

### Device info

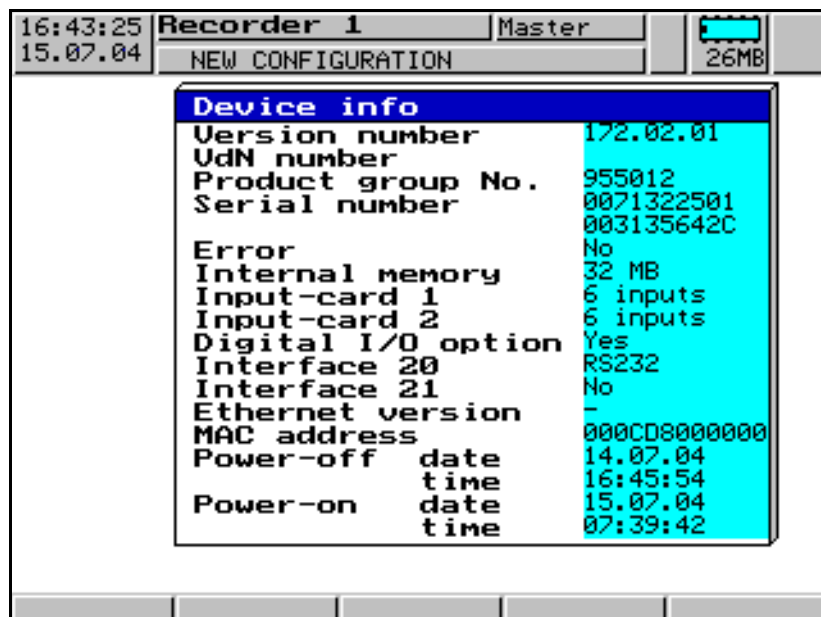

### 3 Operation and visualization

---

#### Error

The following errors may occur:

Error	Description
none	Instrument OK
Data lost	<p>A discharge of the lithium battery/storage capacitor occurred during the last lengthy power interruption.</p> <p>Consequently, the measurement data stored up to now in the SRAM only will be lost. The data in the internal backup memory will be retained. The clock is set to 01.01.97, 00:00:00 hrs.</p> <p>Remedy: For instruments with storage capacitor: reset the time (⇒ page 70). For instruments with lithium battery: return instrument to the supplier for a change of battery.</p>
Battery ↓	<p>The lithium battery is discharged.</p> <p>Remedy: Return instrument to the supplier for a change of battery.</p>



Data may be lost after disconnecting the instrument from the supply: after more than > 4 years on instruments with a lithium battery, and after approx. > 2 days (ambient temperature 15 – 25°C) with storage capacitor.



# 3 Operation and visualization



## 3.8 Text entry

**Entry options** The configurable texts can be entered either through the setup program or on the instrument itself. This section describes the entry on the instrument.

**Character selection** The screen below is shown when a text (e.g. *Configuration* → *Group config.* → *Group 1* → *Group name*) has been selected at the configuration level for editing using **[ENTER]**.

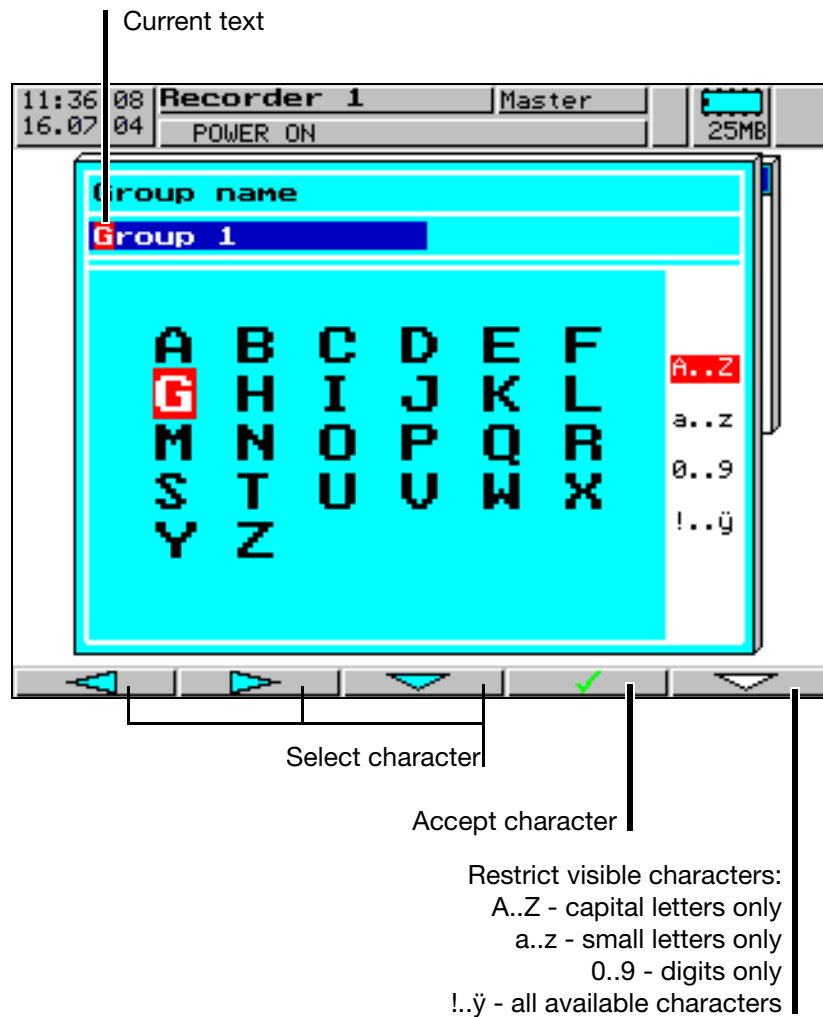
You are automatically in the editing mode.

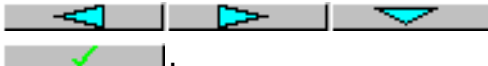

**Character entry** Select the required character (the required digit) using the  buttons and confirm entry with .

After the entire text has been entered, it can either be accepted or all alterations canceled.

\* Enter text with **[ENTER]**

or

\* cancel text entry with **[EXIT]**

### 3 Operation and visualization

#### Character restriction

Using the  button, you can restrict the number of visible characters. The fewer characters are displayed, the easier the selection.

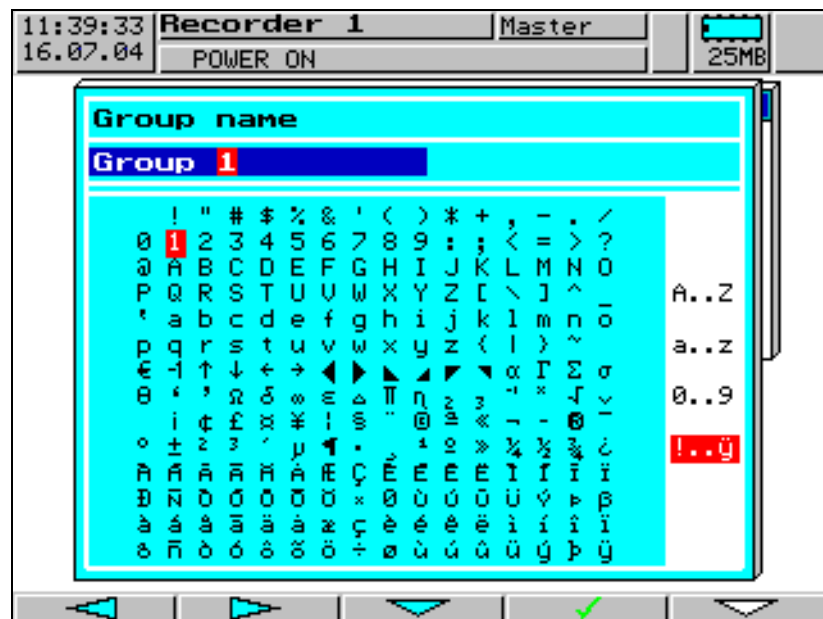
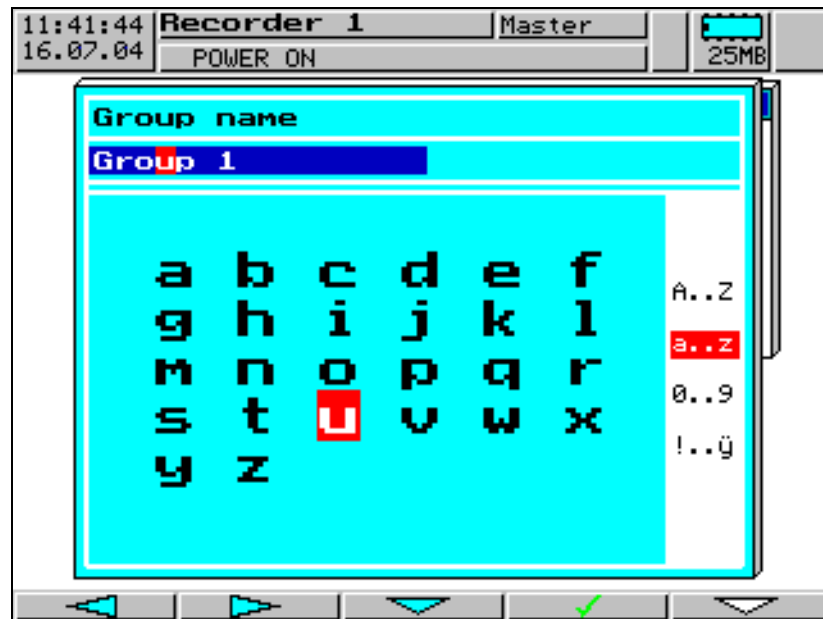

# 4 Configuration parameters

## 4.1 Operating example

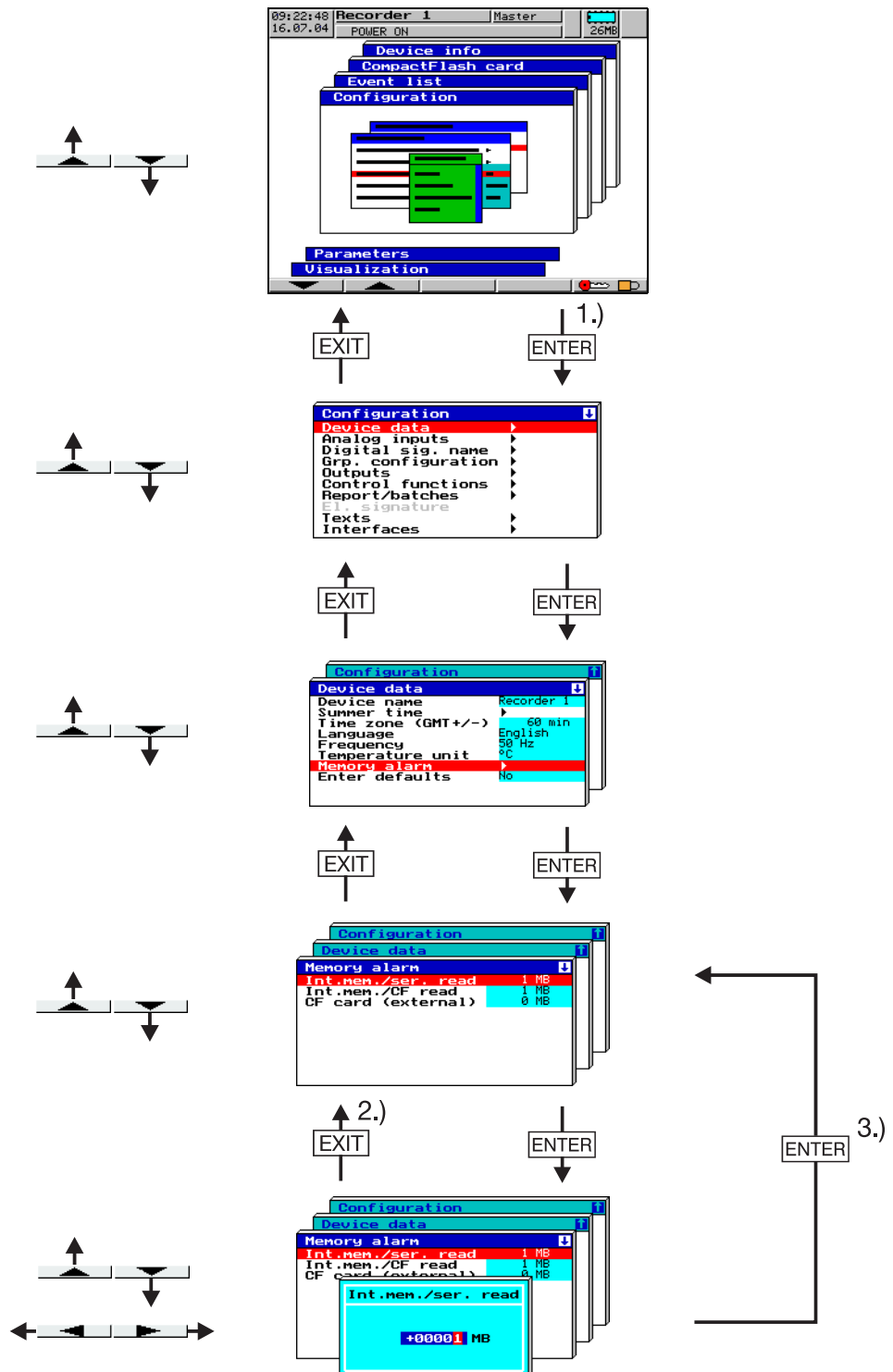

- 1.) A user who has configuration authorization must be logged in.
- 2.) Cancel entry; the old settings are retained
- 3.) Accept entry

## 4 Configuration parameters

---

### 4.2 Table of configuration parameters

The table below lists all the instrument parameters. The order in which the parameters are explained corresponds to the order in which they appear on the instrument (in the menu structure).

The first column describes the path via the menus and windows to the particular parameter.

The second column lists the possible settings for the parameters or the possible selections. The factory default setting in this column is shown **bold**.

The third column contains a description of the parameter, or the possible selections, if the parameter and its function or selection is not self-evident.

#### **Note**

“Instruments” are referred to as “devices” in the software and are referred to as such in the following.

## 4 Configuration parameters

### 4.2.1 Parameterization

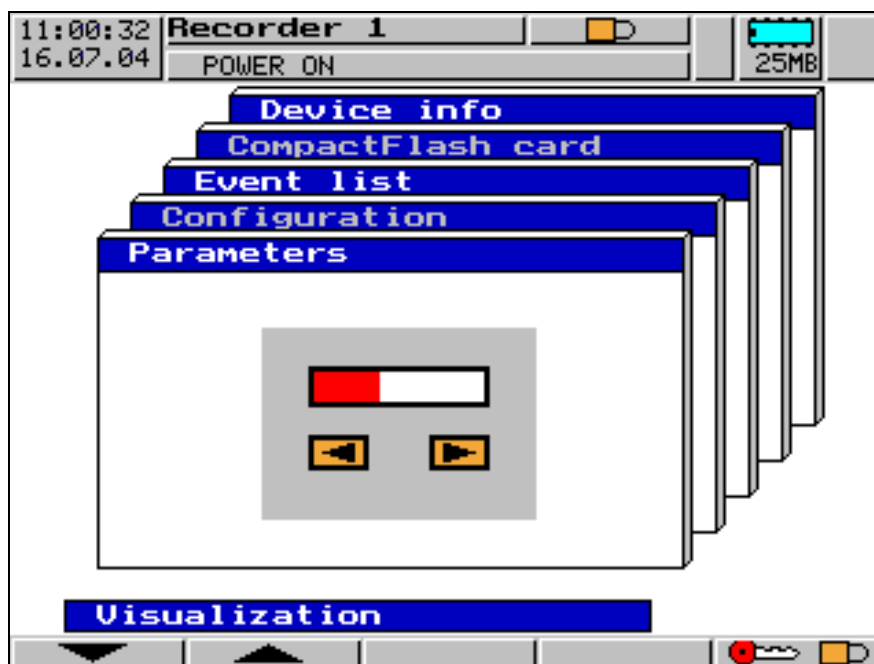

	Parameter	Value/selection	Description
<b>Contrast</b>	Parameterization → Contrast	0 – 13 – 31	Display brightness
<b>Speed indication</b>	Parameterization → Speed indication	in mm/h, <b>time/div</b>	
<b>CF card (external)</b> (memory display)	Parameterization → Memory display → CF card (external)	Always, <b>If plugged in</b> , Never	Your can select here if and how the available memory of the external CompactFlash memory card is displayed in the status line.
<b>Int. memory: for</b> (memory display)	Parameterization → Memory display → Int. memory: for	Ser. read-out <b>Read-out via CF</b>	⇒ See “Memory display” on page 53.
<b>Switch-off event</b> (display off)	Parameterization → Display off → Switch-off event	<b>Waiting time</b> , Control signal	The type of display switch-off is selected here
<b>Waiting time</b> (display off)	Parameterization → Display off → Waiting time	<b>0 – 32767 min</b>	Time after which the display is switched off. Any key stroke will re-activated the display. The parameter can only be entered if the parameter Switch-off event is set on “Waiting time”. 0 = display not off

## 4 Configuration parameters

<b>Control signal</b> (display off)	Parameterization → Display off → Control signal	<b>Off</b> , LogInp.1 – 7, Alarm Gr.1 – 6, Combination alarm, Logged in, Error, Modbus flag, Ext. Inp. 1 – 6, CF plugged in, stolen CF, Int. mem. al./CF, int. mem. al./ser, Mem. al./CF card	If the selected input or signal is activated, the display is switched off. The parameter can only be entered if the parameter Switch-off event is set to “Control signal”.
<b>Calibration status</b> (fine calibration)	Parameterization → Fine calibration → Analog input 1 – 12 → Calibration status	<b>Off</b> , On	A calibration (adjustment) of the analog measurements can be activated here. The adjustment is carried out using a linear equation.
<b>Actual start value</b> (fine calibration)	Parameterization → Fine calibration → Analog input 1 – 12 → Actual start val.	-99999 to <b>0</b> to +99999	Start value of the actual line. Only active when calibration status = On.
<b>Target start value</b> (fine calibration)	Parameterization → Fine calibration → Analog input 1 – 12 → Target start val.	-99999 to <b>0</b> to +99999	Start value of the target line. Only active when calibration status = On.
<b>Actual end value</b> (fine calibration)	Parameterization → Fine calibration → Analog input 1 – 12 → Actual end val.	-99999 to <b>1000</b> to +99999	End value of the actual line. Only active when calibration status = On.
<b>Target end value</b> (fine calibration)	Parameterization → Fine calibration → Analog input 1 – 12 → Target end val.	-99999 to <b>1000</b> to +99999	End value of the target line. Only active when calibration status = On.
<b>Example for fine calibration</b>	<p>Systematic errors, such as those caused by an unsuitable probe mounting, for example, can be compensated through fine calibration.</p> <p>Example: A probe provides measurements that cover a temperature range from 200 to 300 °C. It has been installed in a tunnel oven so unfavorably as to always indicate 10 °C less than the temperature of the charge. The incorrect measurement can be corrected through fine calibration.</p> <p>Actual start value : 200 °C            Target start value : 210 °C            Actual end value : 300 °C            Target end value : 310 °C</p>		
<b>Date</b>	Parameterization → Date and time → Date	any date	Entry of the current date
<b>Time</b>	Parameterization → Date and time → Time	any time	Entry of the current time

# 4 Configuration parameters

## 4.2.2 Configuration

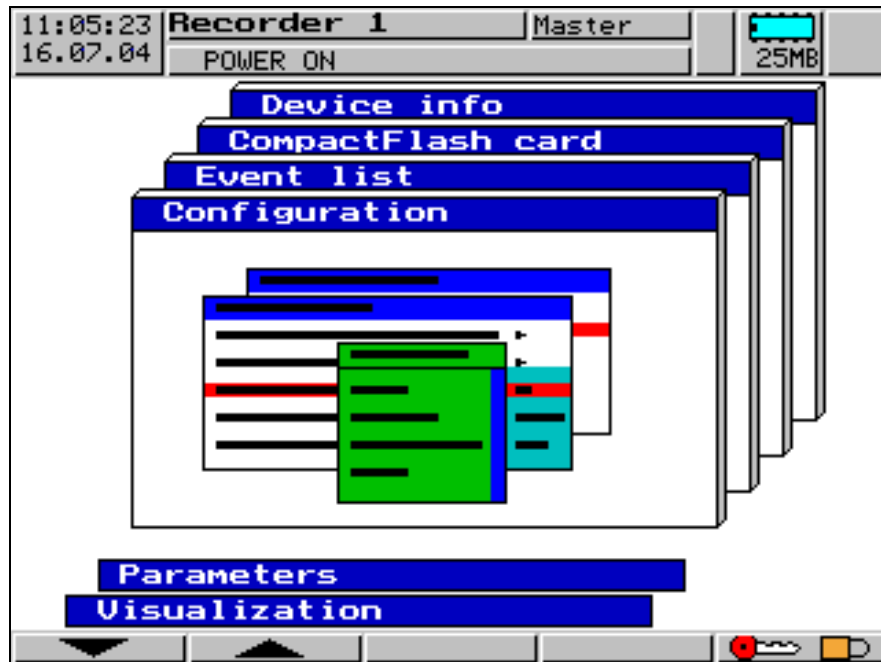

### Configuration → Device data

	Parameter	Value/selection	Description
<b>Device name</b>	Configuration → Device data → Device name	16 characters	⇒ Chapter 3.8 “Text entry”
<b>Summer time changeover (switch)</b>	Configuration → Device data → Summer time → Switch	Off, User timed, <b>Automatic</b>	Automatic: 2:00 hrs or 3:00 hrs on the last Sunday in March or October
<b>Start date (summer time)</b>	Configuration → Device data → Summer time → Start date	any date	
<b>Start time (summer time)</b>	Configuration → Device data → Summer time → Start time	any time	
<b>End date (summer time)</b>	Configuration → Device data → Summer time → End date	any date	
<b>End time (summer time)</b>	Configuration → Device data → Summer time → End time	any time	



## 4 Configuration parameters

	Parameter	Value/selection	Description
<b>Time zone (GMT dev.)</b>	Configuration → Device data → Time zone (GMT dev.)	-720 to <b>60</b> to +720min	Enter here the deviation of your time zone from GMT (Greenwich Mean Time). For Germany, these are 60 min (= 1h). The summer time must not be taken into account.
<b>Language</b>	Configuration → Device data → Language	<b>German</b> , English, French	Select the language for displaying the device texts.
<b>Supply frequency</b>	Configuration → Device data → Supply frequency	<b>50</b> , 60Hz	
<b>Temperature unit</b>	Configuration → Device data → Temperature unit	°C, °F	
<b>Int.mem./ser. read-out (memory alarm)</b>	Configuration → Device data → Memory alarm → Int.mem./ser. read-out	0 – <b>1</b> – 256MB	Limit for the available memory with respect to reading out data via the interface. ⇒ See “Digital signals” on page 19.
<b>Int.mem./read-out via CF (memory alarm)</b>	Configuration → Device data → Memory alarm → Int.mem./read-out via CF	0 – <b>1</b> – 256MB	Limit for the available memory with respect to reading out data via the CompactFlash memory card. ⇒ See “Digital signals” on page 19.
<b>CF card (external) (memory alarm)</b>	Configuration → Device data → Memory alarm → CF card (external)	<b>0</b> – 256MB	Limit for the available memory of the external CompactFlash memory card. ⇒ See “Digital signals” on page 19.
<b>Factory setting</b>	Configuration → Device data → Enter defaults	<b>No</b> , Yes	Yes = accept factory setting.  The parameter automatically returns to “No” after acceptance.

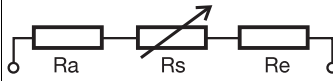

## 4 Configuration parameters

### Configuration → Analog inputs

	Parameter	Value/selection	Description
<b>Sensor</b> (internal analog inputs and counters)	Configuration → Analog inputs → Analog input 1 – 12 → Sensor	Off, Res. therm., Thermocouple, <b>Current</b> , Voltage, Res. transm., Potentiom., Counter	Depending on the sensor that was selected, only the relevant parameters can be selected when configuring the analog input. ⇒ Chapter 2.5 “Counters”
<b>Linearization</b> (internal analog inputs)	Configuration → Analog inputs → Analog input 1 – 12 → Linearization	<b>Linear</b> , Pt100, Pt100 JIS, Ni100, Pt500, Pt1000, Fe-Con J, NiCrCon E, Ni-CrNi K, NiCrSi N, Cu-Con T, PtRhPtRh B, PtRh-Pt R, PtRh-Pt S, Cu-Con U, Fe-Con L Chromel-Copel, Cu50	
<b>Connection circuit</b> (internal analog inputs)	Configuration → Analog inputs → Analog input 1 – 12 → Connection circuit	2 wire, <b>3 wire</b> , 4 wire	Only for sensor: resistance thermometer and potentiometer
<b>Cold junction</b> (internal analog inputs)	Configuration → Analog inputs → Analog input 1 – 12 → Cold junction	<b>Intern.Pt100</b> Extern const	Only for sensor: thermocouple
<b>External cold junction temperature</b> (internal analog inputs)	Configuration → Analog inputs → Analog input 1 – 12 → Ext. CJtemp.	-50 to <b>+50</b> to +100 °C	External cold junction temperature for thermocouples
<b>Range start</b> (internal analog inputs)	Configuration → Analog inputs → Analog input 1 – 12 → Range start	any value <b>0mA</b>	Not for sensor: resistance transmitter and potentiometer
<b>Range end</b> (internal analog inputs)	Configuration → Analog inputs → Analog input 1 – 12 → Range end	any value <b>20mA</b>	Not for sensor: resistance transmitter and potentiometer
<b>Resistance Ra, Rs, Re</b> (internal analog inputs)	Configuration → Analog inputs → Analog input 1 – 12 → Resistance Ra, Rs, Re	0 – 4000Ω	Only for sensor: resistance transmitter: 
<b>Resistance Ro, Rp</b> (internal analog inputs)	Configuration → Analog inputs → Analog input 1 – 12 → Resistance Ro, Rp	0 – 4000Ω	Only for sensor: potentiometer: 

## 4 Configuration parameters

	Parameter	Value/selection	Description
<b>Start temperature</b> (internal analog inputs)	Configuration → Analog inputs → Analog input 1 – 12 → Start temperature	any value	Only for sensor: current, voltage with linearization, resistance thermometer, thermocouple. Only for signals that have not yet been linearized.
<b>End temperature</b> (internal analog inputs)	Configuration → Analog inputs → Analog input 1 – 12 → End temperature	any value	Only for sensor: current, voltage with linearization, resistance thermometer, thermocouple. Only for signals that have not yet been linearized.
<b>Scaling start</b> (internal analog inputs and counters)	Configuration → Analog inputs → Analog input 1 – 12 Counter 1 – 2 → Scaling start	-99999 to <b>0</b> to +99999	Only for sensor: current, voltage with straight-line linearization, for sensor: resistance transmitter and potentiometer, and for counter inputs.
<b>Scaling end</b> (internal analog inputs and counters)	Configuration → Analog inputs → Analog input 1 – 12 Counter 1 – 2 → Scaling end	-99999 to <b>+100</b> to +99999 (with analog input) or -99999 to <b>+10000</b> to +99999 (with counters)	Only for sensor: current, voltage with straight-line linearization, for sensor: resistance transmitter and potentiometer, and for counter inputs
<b>Filter constant</b> (internal analog inputs)	Configuration → Analog inputs → Analog input 1 – 12 → Addit'l parameters → Filter constant	0.0 – <b>0.1</b> – 10.0s	
<b>Channel name</b> (internal analog inputs and counters)	Configuration → Analog inputs → Analog input 1 – 12 Counter 1 – 2 → Addit'l parameters → Channel name	7 characters <b>Inp. x</b> or <b>counter.x</b>	Short designation. It is shown in all diagram representations.  ⇒ Chapter 3.8 “Text entry”
<b>Channel description</b> (internal analog inputs and counters)	Configuration → Analog inputs → Analog input 1 – 12 Counter 1 – 2 → Addit'l parameters → Channel description	2 x 20 characters <b>Meas. inp. x</b> or <b>event counter x</b>	Detailed description. It is additionally shown in the two numerical displays.  ⇒ Chapter 3.8 “Text entry”
<b>Unit</b> (internal analog inputs and counters)	Configuration → Analog inputs → Analog input 1 – 12 Counter 1 – 2 → Addit'l parameters → Unit	5 characters % (only with analog input, no pre-assignment for counter input)	⇒ Chapter 3.8 “Text entry”

## 4 Configuration parameters

	Parameter	Value/selection	Description
<b>Decimal place</b> (internal analog inputs and counters)	Configuration → Analog inputs → Analog input 1 – 12 Counter 1 – 2 → Addit'l parameters → Decimal place	Automatic, X.XXXX, XX.XXX, XXX.XX, <b>XXXX.X</b> , (with analog inp.), <b>XXXXX</b> .(with counters)	Automatic: representation with maximum resolution
<b>Integrator time base</b> (internal analog inputs)	Configuration → Analog inputs → Analog input 1 – 12 → Addit'l parameters → Integr. time base	<b>Off</b> , Second, Minute, Hour, Day	Time base for the integrator. If the time base is switched off, the integrator indication is suppressed in the report. ⇒ Chapter 2.6 “Integrator”
<b>Integrator unit</b> (internal analog inputs)	Configuration → Analog inputs → Analog input 1 – 12 → Addit'l parameters → Integr. unit	5 characters	⇒ Chapter 2.6 “Integrator”
<b>Sensor</b> (external analog inputs and counters)	Configuration → Analog inputs → External input 1 – 36 External counter 1 – 2 → Sensor	<b>Off</b> , Ext. input, Ext. counter	⇒ Chapter 2.3 “Analog inputs” ⇒ Chapter 2.5 “Counters”
<b>Scaling start</b> (external analog inputs and counters)	Configuration → Analog inputs → External input 1 – 36 External counter 1 – 2 → Scaling start	-99999 to <b>0</b> to +99999	
<b>Scaling end</b> (external analog inputs and counters)	Configuration → Analog inputs → External input 1 – 36 External counter 1 – 2 → Scaling end	-99999 to <b>+100</b> to +99999 (with analog input) or -99999 to <b>+10000</b> to +99999 (with counters)	
<b>Channel name</b> (external analog inputs and counters)	Configuration → Analog inputs → External input 1 – 36 External counter 1 – 2 → Addit'l parameters → Channel name	7 characters <b>Inp.. x</b> or <b>Ext.c..x</b>	Short designation. It is shown in all diagram representations. ⇒ Chapter 3.8 “Text entry”
<b>Channel description</b> (external analog inputs and counters)	Configuration → Analog inputs → External input 1 – 36 External counter 1 – 2 → Addit'l parameters → Channel description	2 x 20 characters <b>Meas. inp. x</b> <b>(external input)</b> or <b>external event counter x</b>	Detailed description. It is additionally shown in the two numerical displays. ⇒ Chapter 3.8 “Text entry”

## 4 Configuration parameters

	Parameter	Value/selection	Description
<b>Unit</b> (external analog inputs and counters)	Configuration → Analog inputs → External input 1 – 36 External counter 1–2 → Addit'l parameters → Unit	5 characters %	⇒ Chapter 3.8 “Text entry”
<b>Decimal place</b> (external analog inputs and counters)	Configuration → Analog inputs → External input 1 – 36 External counter 1–2 → Addit'l parameters → Decimal place	Automatic, X.XXXX, XX.XXX, XXX.XX, <b>XXXX.X</b> (with analog inp.) <b>XXXXX.</b> (with counter)	Automatic: representation with maximum resolution
<b>Integrator time base</b> (external analog inputs)	Configuration → Analog inputs → External input 1 – 36 → Addit'l parameters → Integr. time base	<b>Off</b> , Second, Minute, Hour, Day	Time base for the integrator. If the time base is switched off, the integrator indication is suppressed in the report. ⇒ Chapter 2.6 “Integrator”
<b>Integrator unit</b> (external analog inputs)	Configuration → Analog inputs → External input 1 – 36 → Addit'l parameters → Integr. unit	5 characters	⇒ Chapter 2.6 “Integrator”

### Configuration → Digital signal name

	Parameter	Value/selection	Description
<b>Digital signal name</b>	Configuration → Digital signal name → Logic input 1 – 7 → Alarm group 1 – 6 → Combination alarm → Logged in → Error → Modbus flag → External input 1 – 6 → CF card plugged in → Stolen CF card → Int. mem. al./via CF → Int. mem. al./serial → Memory alarm CF card	7 characters  <b>LogInp 1 – 7</b> <b>Al.Gr.1 – 6</b> <b>Alarm</b> <b>Logged in</b> <b>Error</b> <b>MB flag</b>  <b>ExtInp1 – 6</b> <b>CF card</b> <b>CF card</b> <b>Mem. al.</b> <b>Mem. al.</b> <b>Mem. al.</b>	⇒ Chapter 3.8 “Text entry”

## 4 Configuration parameters

### Configuration → Group configuration

	Parameter	Value/selection	Description
<b>Group status</b>	Configuration → Group config. → Group 1 – 6 → Group status	Off, Display only, <b>Displ.+store</b>	Displ.+store.: the channels in the group are shown in the diagrams and stored in the memory.
<b>Group name</b>	Configuration → Group config. → Group 1 – 6 → Group name	16 characters <b>Group x</b>	⇒ Chapter 3.8 “Text entry”
<b>Input signal</b> (analog channels, group 1 – 6)	Configuration → Group config. → Group 1 – 6 → Analog channels → Analog channel 1 – 6 → Input signal	Off, Analog inp.1 – 12, Ext. Inp. 1 – 36, Counter 1 – 2 Ext. counter 1 – 2  Group 1: <b>A. inp. 1 – 6</b> Group 2: <b>A. inp. 7 – 12</b>	Assignment of the hardware inputs to the channels of the group
<b>Line width</b> (analog channels, group 1 – 6)	Configuration → Group config. → Group 1 – 6 → Analog channels → Analog channel 1 – 6 → Line width	<b>Thin</b> , Thick	For diagram representation
<b>Alarms</b> (analog channels, group 1 – 6)	Configuration → Group config. → Group 1 – 6 → Analog channels → Analog channel 1 – 6 → Alarms	<b>Off</b> , Activated	
<b>Low limit</b> (analog channels, group 1 – 6)	Configuration → Group config. → Group 1 – 6 → Analog channels → Analog channel 1 – 6 → Low limit	-99999 to <b>0</b> to +99999	
<b>High limit</b> (analog channels, group 1 – 6)	Configuration → Group config. → Group 1 – 6 → Analog channels → Analog channel 1 – 6 → High limit	-99999 to <b>0</b> to +99999	

# 4 Configuration parameters

**Differential (hysteresis)**  
(analog channels, group 1 – 6)

Parameter	Value/selection	Description	
Configuration → Group config. → Group 1 – 6 → Analog channels → Analog channel 1 – 6 → Differential	-99999 to 0 to +99999		
(1) = Low limit (2) = High limit (3) = Differential			
<b>Text low alarm</b> (analog channels, group 1 – 6)	Configuration → Group config. → Group 1 – 6 → Analog channels → Analog channel 1 – 6 → Text low alarm	<b>Standard text,</b> Text 1 – 146, No text	⇨ Chapter 3.5 “Event list” ⇨ Configuration → Texts, page 86
<b>Text high alarm</b> (analog channels, group 1 – 6)	Configuration → Group config. → Group 1 – 6 → Analog channels → Analog channel 1 – 6 → Text high alarm	<b>Standard text,</b> Text 1 – 146, No text	⇨ Chapter 3.5 “Event list” ⇨ Configuration → Texts, page 86
<b>Alarm delay</b> (analog channels, group 1 – 6)	Configuration → Group config. → Group 1 – 6 → Analog channels → Analog channel 1 – 6 → alarm delay	0 – 32767s	Alarm delay is activated at a value of <> 0. When activated, an alarm will only be generated when it has been present for at least as long as it takes for the set time to elapse.

## 4 Configuration parameters

	Parameter	Value/selection	Description
<b>Input signal (digital channels, group 1 – 6)</b>	Configuration → Group config. → Group 1 – 6 → Digital channels → Digital channel 1 – 3 → Input signal	Off, LogInp.1 – 7, Alarm Gr.1 – 6, Combination alarm, Logged in, Error, Modbus flag Ext. Inp. 1 – 6, CF plugged in Stolen CF Int. mem. al./CF, Int. mem. al./ser, Mem. al./CF card  <b>Logic inp. x</b>	Assignment of the hardware inputs or the signals generated by the software to the digital channels of the group.
<b>Measurement representation Vertical diagram (group 1 – 6)</b>	Configuration → Group config. → Group 1 – 6 → Measurement representation → Vertic. diagram	Off, <b>On</b>	If measurement representation is <i>Off</i> , it cannot be called up in visualization. It will be skipped automatically when switching measurement representation.
<b>Measurement representation Horizont. diagram (group 1 – 6)</b>	Configuration → Group config. → Group 1 – 6 → Measurement representation → Horizont. diagram	Off, <b>On</b>	
<b>Measurement representation Bar graph (group 1 – 6)</b>	Configuration → Group config. → Group 1 – 6 → Measurement representation → Bar graph	Off, <b>On</b>	
<b>Measurement representation Numerical display (group 1 – 6)</b>	Configuration → Group config. → Group 1 – 6 → Measurement representation → Numerical display	Off, <b>On</b>	

## 4 Configuration parameters

	Parameter	Value/selection	Description
<b>Measurement representation Report</b> (group 1 – 6)	Configuration → Group config. → Group 1 – 6 → Measurement representation → Report	Off, <b>On</b>	
<b>Measurement representation Batch</b> (group 1 – 6)	Configuration → Group config. → Group 1 – 6 → Measurement representation → Batch	Off, <b>On</b>	
<b>Store status Normal operation</b> (group 1 – 6)	Configuration → Group config. → Group 1 – 6 → Normal operation → Store status	Off, <b>On</b>	
<b>Stored value Normal operation</b> (group 1 – 6)	Configuration → Group config. → Group 1 – 6 → Normal operation → Stored value	Average val., <b>Instant val.,</b> Minimum, Maximum	⇒ Chapter 2.7 “Operating modes” Chapter 2.8 “Storing data”
<b>Storage cycle Normal operation</b> (group 1 – 6)	Configuration → Group config. → Group 1 – 6 → Normal operation → Storage cycle	0 – <b>60</b> – 32767s	⇒ Chapter 2.7 “Operating modes” Chapter 2.8 “Storing data”  Setting 0s = Storage cycle 125ms
<b>Control signal Event operation</b> (group 1 – 6)	Configuration → Group config. → Group 1 – 6 → Event operation → Control signal	<b>Off</b> , LogInp.1 – 7, Alarm Gr.1 – 6, Combination alarm, Logged in, Error, Modbus flag Ext. Inp. 1 – 6, CF plugged in Stolen CF Int. mem. al./CF, Int. mem. al./ser, Mem. al./CF card	When the configured signal is active, the device switches to event operation.
<b>Stored value Event operation</b> (group 1 – 6)	Configuration → Group config. → Group 1 – 6 → Event operation → Stored value	Average val., <b>Instant val.,</b> Minimum, Maximum	⇒ Chapter 2.7 “Operating modes” Chapter 2.8 “Storing data”
<b>Storage cycle Event operation</b> (group 1 – 6)	Configuration → Group config. → Group 1 – 6 → Event operation → Storage cycle	0 – <b>5</b> – 32767s	⇒ Chapter 2.7 “Operating modes” Chapter 2.8 “Storing data”



## 4 Configuration parameters

	Parameter	Value/selection	Description
<b>Start time</b> <b>Timed operation</b> (group 1 – 6)	Configuration → Group config. → Group 1 – 6 → Timed operation → Start time	any time	Off when Start time = End time
	Configuration → Group config. → Group 1 – 6 → Timed operation → End time	any time	
<b>Stored value</b> <b>Timed operation</b> (group 1 – 6)	Configuration → Group config. → Group 1 – 6 → Timed operation → Stored value	Average val., <b>Instant val.,</b> Minimum, Maximum	⇒ Chapter 2.7 “Operating modes” Chapter 2.8 “Storing data”
<b>Storage cycle</b> <b>Timed operation</b> (group 1 – 6)	Configuration → Group config. → Group 1 – 6 → Timed operation → Storage cycle	0 – 5 – 32767s	⇒ Chapter 2.7 “Operating modes” Chapter 2.8 “Storing data”

### Configuration → Outputs

	Parameter	Value/selection	Description
<b>Action</b> <b>Outputs</b>	Configuration → Outputs → Relay K1 → Action	Off, make (n.o.), <b>break (n.c.)</b>	
<b>Control signal</b> <b>Outputs</b>	Configuration → Outputs → Relay K1 → Control signal	Off, LogInp.1 – 7, Alarm Gr.1 – 6, Combination alarm, Logged in, <b>Error,</b> Modbus flag Ext. Inp. 1 – 6, CF plugged in Stolen CF Int. mem. al./CF, Int. mem. al./ser, Mem. al./CF card	The configured signal is output to the relay.
<b>Action</b> <b>outputs</b>	Configuration → Outputs → Relay K2 – K5, Open collector → Action	<b>Off,</b> make (n.o.), break (n.c.)	

## 4 Configuration parameters

	Parameter	Value/selection	Description
<b>Control signal Outputs</b>	Configuration → Outputs → Relay K2 – K5, Open collector → Control signal	Off, LogInp.1 – 7,, <b>Alarm Gr.1 – 5,,</b> Alarm Gr.6, Combination alarm, Logged in, Error, Modbus flag, Ext. Inp. 1 – 6, CF plugged in, Stolen CF, Int. mem. al./CF, Int. mem. al./ser,, Mem. al./CF card	The configured signal is output to the relay.

### Configuration → Control functions

	Parameter	Value/selection	Description
<b>Control signal (counters)</b>	Configuration → Control functions → Counters → Counter 1 – 2 → Control signal	<b>Off</b> , LogInp.1 – 7, Alarm Gr.1 – 6, Combination alarm, Logged in, Error, Modbus flag Ext. Inp. 1 – 6, CF plugged in Stolen CF Int. mem. al./CF, Int. mem. al./ser, Mem. al./CF card	The counter is incremented or decremented when the control signal becomes active. ⇒ Chapter 2.5 “Counters”
<b>Start value (counters)</b>	Configuration → Control functions → Counters → Counter 1 – 2/ Ext. counter 1 – 2 → Start value	-9999 to <b>0</b> to +9999	Sets the counter to the specified value. ⇒ Chapter 2.5 “Counters”
<b>Counting direction (counters)</b>	Configuration → Control functions → Counters → Counter 1 – 2/ Ext. counter 1 – 2 → Counting direction	<b>Up</b> , Down	⇒ Chapter 2.5 “Counters”
<b>Text (counters)</b>	Configuration → Control functions → Counters → Counter 1 – 2/ Ext. counter 1 – 2 → Text	<b>Standard text</b> , Text 1 – 146, No text	⇒ Chapter 2.5 “Counters” Chapter 3.5 “Event list” ⇒ Configuration → Texts, page 86

## 4 Configuration parameters

	Parameter	Value/selection	Description
<b>External texts</b> (logic inputs)	Configuration → Control functions → External texts → Logic input 1 – 7/External input 1 – 6	Standard text, Text 1 – 146, <b>No text</b>	⇒ Chapter 3.5 “Event list” ⇒ Configuration → Texts, page 86
<b>Key inhibit</b>	Configuration → Control functions → Key inhibit	<b>Off</b> , LogInp.1 – 7, Alarm Gr.1 – 6, Combination alarm, Logged in, Error, Modbus flag Ext. Inp. 1 – 6, CF plugged in Stolen CF Int. mem. al./CF, Int. mem. al./ser, Mem. al./CF card	The keys are inhibited as soon as the selected logic input is closed.
<b>Time synchronization</b>	Configuration → Device data → Date and time → Time synchroniz.	<b>Off</b> , LogInp.1 – 7, Alarm Gr.1 – 6, Combination alarm, Logged in, Error, Modbus flag Ext. Inp. 1 – 6, CF plugged in Stolen CF Int. mem. al./CF, Int. mem. al./ser, Mem. al./CF card	Using this parameter or this function, the system clocks of several recorders can be synchronized simultaneously. When a logic input has been selected and is operated (transition from “Low” to “High”), then the time can be synchronized. The seconds are decisive in the time change. They are used for rounding the time up or down. Example: 12:55:29 -> 12:55:00 12:55:30 -> 12:56:00

### Configuration → Report/Batches

	Parameter	Value/selection	Description
<b>Periodic report</b>	Configuration → Report/Batches → Periodic report	<b>Off</b> , On	If a report is <i>Off</i> , it cannot be called up. It will be skipped automatically when switching reports.
<b>External report/ Batches</b>	Configuration → Report/Batches → Ext. report/Batches → Status	<b>Off</b> , Only Ext. rep., E.R.+batches	Activates the external report and the batch report, if required. ⇒ Chapter 3.2.8 “Batch reports”

## 4 Configuration parameters

	Parameter	Value/selection	Description
<b>Control signal</b> (Ext.report/ Batches)	Configuration → Report/Batches → Ext. report/Batches → Control signal	LogInp. 1 – 7, Alarm Gr.1 – 6, Combination alarm, Logged in, Error, Modbus flag Ext. Inp. 1 – 6, CF plugged in Stolen CF Int. mem. al./CF, Int. mem. al./ser, Mem. al./CF card	If the status of the external report or the batch report is not set to OFF, the report is started and completed by activating the control signal
<b>Text (left column)</b> (Ext.report/ Batches)	Configuration → Report/Batches → Ext. report/Batches → Batches → Line 1 – 10 → Text left column	any text	The texts in the left column of a batch report are entered here. ⇒ Chapter 3.2.8 “Batch reports” ⇒ Chapter 3.8 “Text entry”
<b>Contents right column</b> (Ext.report/ Batches)	Configuration → Report/Batches → Ext. report/Batches → Batches → Line 1 – 10 → Contents right column	<b>No entry,</b> Fixed text, Text list, Bin.-linked text, from interface, Batch No., Batch start, Batch end, Batch duration	Determines how the text in the right-hand column of a batch report is formed. ⇒ Chapter 3.2.8 “Batch reports”
<b>Binary-linking</b> (Ext.report/ Batches)	Configuration → Report/Batches → Ext. report/Batches → Batches → Line 1 – 10 → Binary linking	<b>Logic inp1-2,</b> Logic inp1-3, Logic inp1-4, Logic inp1-5, Logic inp1-6,	Through binary linking, up to 64 different texts can be incorporated into the batch report by means of the logic inputs (depending on the setting). ⇒ Chapter 3.2.8 “Batch reports”
<b>from text No.</b> (Ext.report/ Batches)	Configuration → Report/Batches → Ext. report/Batches → Batches → Line 1 – 10 → from text No.	1 – 146	First text in the internal text list. Only used for “right-hand column = text list” and “right-hand column = binary linking”. ⇒ Chapter 3.2.8 “Batch reports”
<b>to text No.</b> (Ext.report/ Batches)	Configuration → Report/Batches → Ext. report/Batches → Batches → Line 1 – 10 → to text No.	1 – 2 – 146	Last text in the internal text list. Only used for “right-hand column = text list”. ⇒ Chapter 3.2.8 “Batch reports”

## 4 Configuration parameters

	Parameter	Value/selection	Description
<b>Default text</b> (Ext.report/ Batches)	Configuration → Report/Batches → Ext. report/Batches → Batches → Line 1 – 10 → Default text	any text	Only used for “right-hand column = fixed text”. ⇒ Chapter 3.2.8 “Batch reports” ⇒ Chapter 3.8 “Text entry”
<b>Text editable?</b> (Ext.report/ Batches)	Configuration → Report/Batches → Ext. report/Batches → Batches → Line 1 – 10 → Text editable?	<b>Yes,</b> No	“Yes” means that the preset text can still be altered, as long as the batch has not been completed. ⇒ Chapter 3.2.8 “Batch reports” ⇒ Chapter 3.8 “Text entry”
<b>Daily report</b>	Configuration → Report/Batches → Daily report	<b>Off,</b> On	If a report is <i>Off</i> , it cannot be called up. It will be skipped automatically when switching reports.
<b>Monthly report</b>	Configuration → Report/Batches → Monthly report	<b>Off,</b> On	
<b>Annual report</b>	Configuration → Report/Batches → Annual report	<b>Off,</b> On	
<b>Period</b> (report)	Configuration → Report/Batches → Period	1, <b>2</b> , 3, 4, 5, 10, 15, 30min, 1 ,2 ,3 ,4 ,6 ,8 ,12h	Only for period. report
<b>Synchronization time</b> (report)	Configuration → Report/Batches → Synchronizat. time	any time <b>00:00:00</b>	All reports except external report. Example: Setting: Synchronizat. time = 03.00 period = 6hrs current time = 02:15 effect: 1st period report = 02:15 - 03:00 2nd period report = 03:00 - 09:00 3rd period report = 09:00 - 15:00 4th ..., daily report = 03:00 of each day, monthly report = 03:00 on first day of each month, annual report = 03:00 on the 1st Jan. of each year

## 4 Configuration parameters

### Configuration → El. signature

The parameters *Configuration → El. signature* are only active on recorders with increased security requirements, but not on this type of recorder.

### Configuration → Texts

	Parameter	Value/selection	Description
Texts	Configuration → Texts	Text 1 – 146	⇒ Chapter 3.8 “Text entry”

### Configuration → Interfaces

	Parameter	Value/selection	Description
<b>20 (RS232/RS4xx)</b>	Configuration → Interfaces → 20 (RS232/RS4xx)		Setting the parameters for the serial interface
<b>Protocol</b> (20 (RS232/RS4xx))	Configuration → Interfaces → 20 (RS232/RS4xx) → Protocol	<b>MODBUS,</b> JBUS	
<b>Baud rate</b> (20 (RS232/RS4xx))	Configuration → Interfaces → 20 (RS232/RS4xx) → Baud rate	<b>9600 baud,</b> 19200 baud, 38400 baud	If possible, the fastest transfer rate should be selected here. The next smaller rate should only be selected if problems arise.
<b>Data format</b> (20 (RS232/RS4xx))	Configuration → Interfaces → 20 (RS232/RS4xx) → Data format	<b>8-1-none,</b> 8-1-odd, 8-1-even, 8-2-none	
<b>Device address</b> (20 (RS232/RS4xx))	Configuration → Interfaces → 20 (RS232/RS4xx) → Device address	<b>1 – 254</b>	
<b>Min. response time</b> (20 (RS232/RS4xx))	Configuration → Interfaces → 20 (RS232/RS4xx) → Min. response time	<b>0 – 500msec</b>	
<b>21 (Profibus-DP)</b>	Configuration → Interfaces → 21 (Profibus-DP)		Setting the parameters for the Profibus-DP interface.
<b>Address</b> (21 (Profibus-DP))	Configuration → Interfaces → 21 (Profibus-DP) → Address	<b>1 – 125 – 127</b>	Setting the address from which the recorder can be addressed in the Profibus-DP network.
<b>Baud rate</b> (21 (Profibus-DP))	Configuration → Interfaces → 21 (Profibus-DP) Baud rate		The baud rate is set automatically by the PROFIBUS-DP master.

## 4 Configuration parameters

	Parameter	Value/selection	Description
<b>Measurement normalization</b> (21 (Profibus-DP))			Additional parameters for the measurement normalization of the internal analog inputs can be configured through the Setup software. For further information, please see the Operating Instructions 9499-040-76511 (Interface Description PROFIBUS-DP).
<b>22 (Ethernet)</b>	Configuration → Interfaces → 22 (Ethernet)		Setting the parameters for the Ethernet interface.
<b>IP address</b> (22 (Ethernet))	Configuration → Interfaces → 22 (Ethernet) → IP address	0.0.0.0 ... <b>192.168.0.10</b> ... 255.255.255.255	IP address of recorder
<b>Subnet mask</b> (22 (Ethernet))	Configuration → Interfaces → 22 (Ethernet) → Subnet mask	0.0.0.0 ... <b>255.255.0.0</b> ... 255.255.255.255	Subnet mask
<b>Gateway</b> (22 (Ethernet))	Configuration → Interfaces → 22 (Ethernet) → Gateway	<b>0.0.0.0</b> – 255.255.255.255	Gateway address to which the recorder is connected.

# 4 Configuration parameters

---



The setup software is used for the easy creation of configuration files, and to configure the devices from a PC.

### 5.1 Hardware and software requirements

The following hardware and software requirements have to be met for installing and operating the setup software:

#### Minimum configuration

- IBM-PC or compatible PC with PentiumIII<sup>1</sup> processor or higher,
- 128Mbyte main memory,
- CD drive,
- mouse,
- one free serial interface or network connection, or CompactFlash memory cards (depending on the type of data transmission to the recorder),
- 120Mbyte free space on hard disk and
- Microsoft Windows<sup>2</sup> NT4.0, 2000 or XP.

In addition, the following items are required for communication between the PC and the recorder, such as:

- reader/writer for CompactFlash memory card or
- PC interface cable including adapter (only when using the setup interface) or
- serial interface cable (when using the RS232C or RS422/485 interface) or
- network connection (when using the Ethernet connection).

#### Recommended configuration

- Pentium IV
- Windows 2000 or XP
- 256Mbyte main memory
- 2GByte free space on hard disk for data

1. Pentium is a registered trademark of the Intel Corporation  
2. Microsoft and Windows are registered trademarks of the Microsoft Corporation

# 5 Setup software

---

## 5.2 Installation

### Running the installation program

- \* Start Microsoft Windows®



If Microsoft Windows has already been started, all Windows programs must be shut down before installing the setup program.

- \* Insert CD into the disk drive, then close it.

After the CD has been inserted, the installation program starts automatically; if not, proceed as follows:

- \* Start the file “Start.exe” in the main directory of the CD.

The installation program will lead you through the rest of the installation with screen messages.



If no valid license number is entered during the installation, the data transmission, data storage and print-out functions are inhibited.

### Program start

- \* Start the setup software by selecting the “Setup program ...” entry in the chosen program folder.

When the software is first installed, there will be no user name and password query. The function *Fresh log-in / Alter password* in the *Extras* menu can be used to activate the query at the program start.

By activating the log-in function, a distinction can be made between the “Specialist” and “Maintenance” users. They have different rights with respect to the functions of the PC Setup software.

⇒ “Fresh log-in / alter password” on page 112

⇒ Chapter 6 “Rights”

If the query is active, proceed as follows:

- \* Log in.

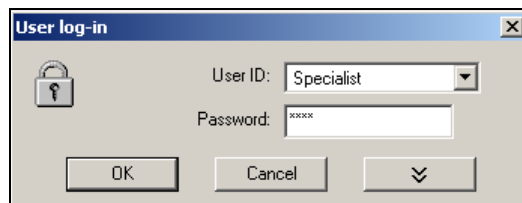

Please note that not all functions are available to all users.

## 5.3 User interface

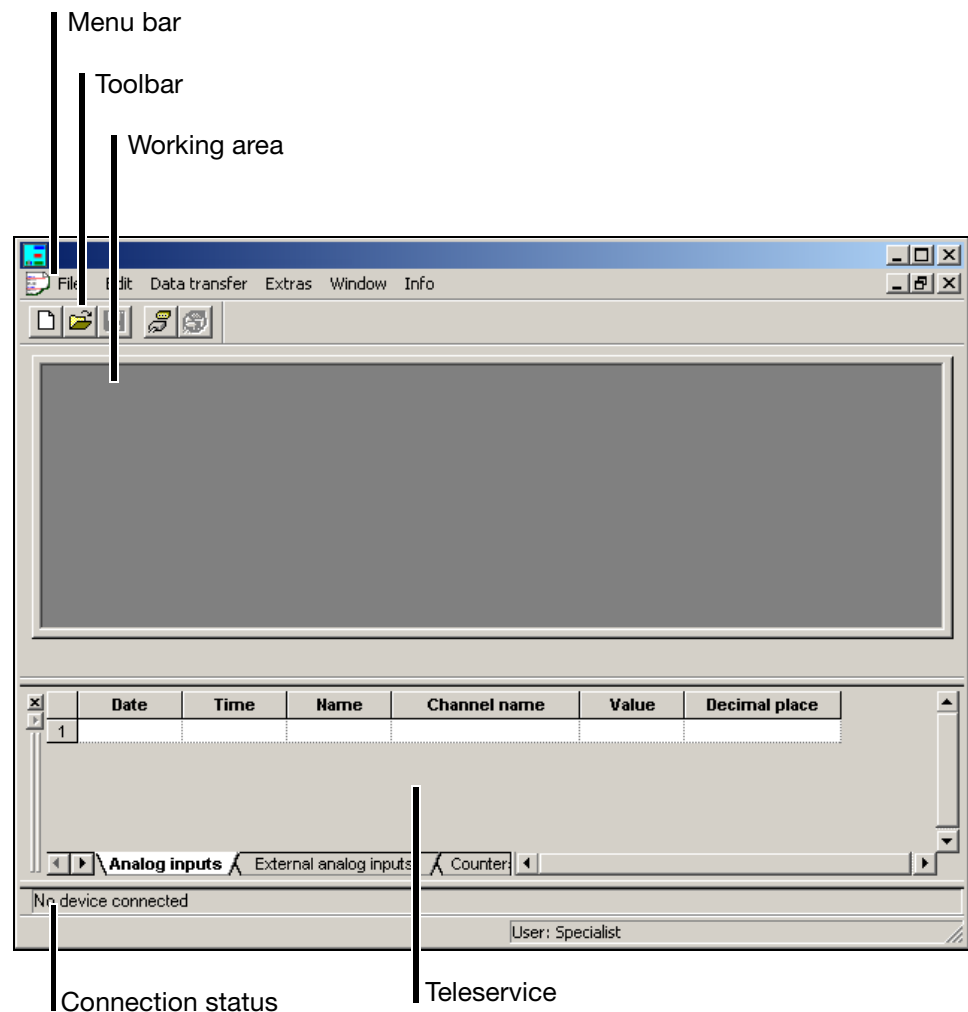

### Menu bar

Using the menu bar, the individual functions of the setup software can be started.

⇒ Chapter 5.8 “Menu functions”

### Toolbar

The tool bar contains selected functions of the menu bar. They can be started from the left mouse button. By resting the mouse pointer on one of the symbols, you will see the function title after a short while.

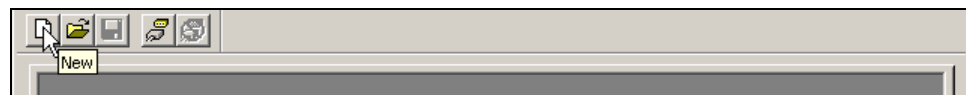

# 5 Setup software

---

## Shifting the toolbar

The position of the toolbar can be changed, if desired.

- \* Move the mouse pointer inbetween two symbol groups.



- \* Press the left mouse button.
- \* Keeping the left mouse button pressed, pull the toolbar to the desired position.
- \* Now release the mouse button.



Possible positions are:

- the left or right window border (vertical orientation),
- below the menu bar (horizontal orientation),
- at the bottom edge, above the user details (horizontal orientation) or
- any position (in its own window - horizontal orientation).

## Working area

Here you are provided with an overview of the current settings of a configuration file.

⇒ Chapter 5.4 “Configuration”

## Connection status

In the “Connection status” line you can verify whether there is a connection to a device, and which interface data are used. The line can be switched into/out of display by using the *Window* → *Connection status* function.

Example: not connected



Example: connected to a device

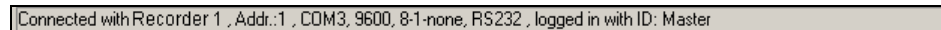

The line can be shifted in the same way as the toolbar. In order to do this, you have to move the mouse pointer to the position shown below, before pressing the left mouse button.

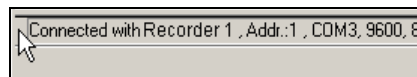

## Teleservice

Using the teleservice, you can view the latest data of the paperless recorder and alter the external inputs and the control flag. The teleservice can be switched into or out of display through the *Window* → *Teleservice* function.

⇒ Chapter 5.5 “Teleservice”

## 5.4 Configuration

By using the function *File* → *New* (or *File* → *Open*) you can create a new configuration file (setup), or open an already existing one. The working area will be filled with the corresponding settings.

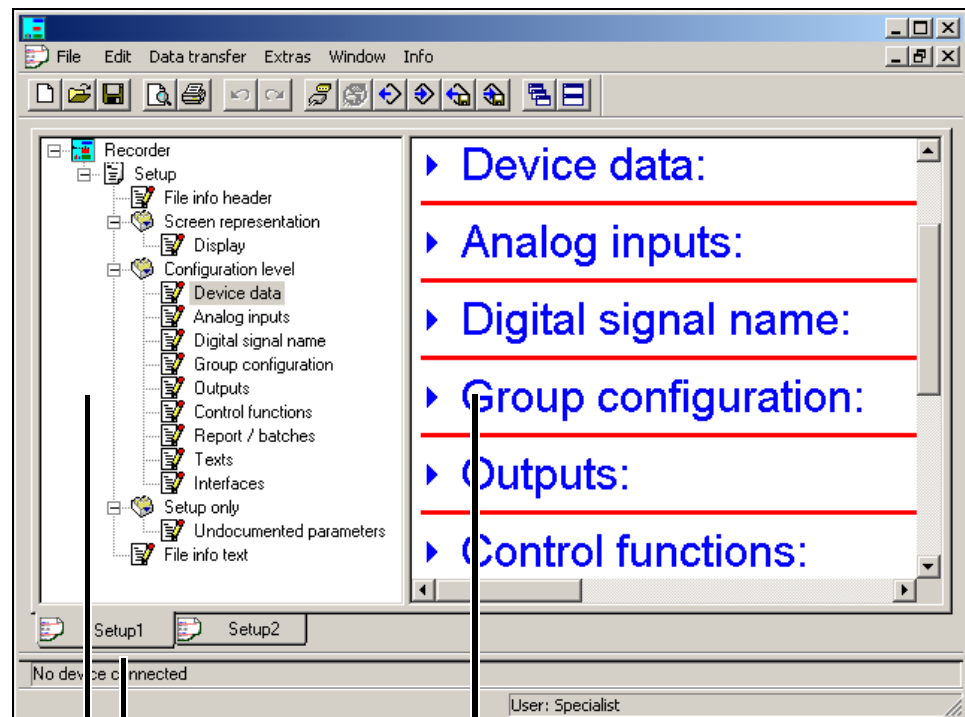

Current setup

**Navigation tree**  
for finding the settings  
quickly

**Dialog window**  
The settings are displayed here.

**Navigation tree** One single click with the left mouse button in the navigation tree will visibly position the entry in the dialog window.

Clicking on will reduce the display, one click on will enlarge it again.

A double-click on an entry (e.g. Device data ) will start the change dialog. Alternatively, a change can also be started via the menu bar (*Edit* → *Configuration level* → *Device data* ).

**Dialog window** By double-clicking on an entry in the dialog window, you can start the change dialog. One click on the “Arrow pointing to right” (▶) in front of the entry will list the current setting in the dialog window, one click on the “Arrow pointing down” (▼) will hide the current setting again.

**Current setup** If several setup settings are open at the same time, one simple click on the name and ...

## 5 Setup software

... the window becomes an active window.

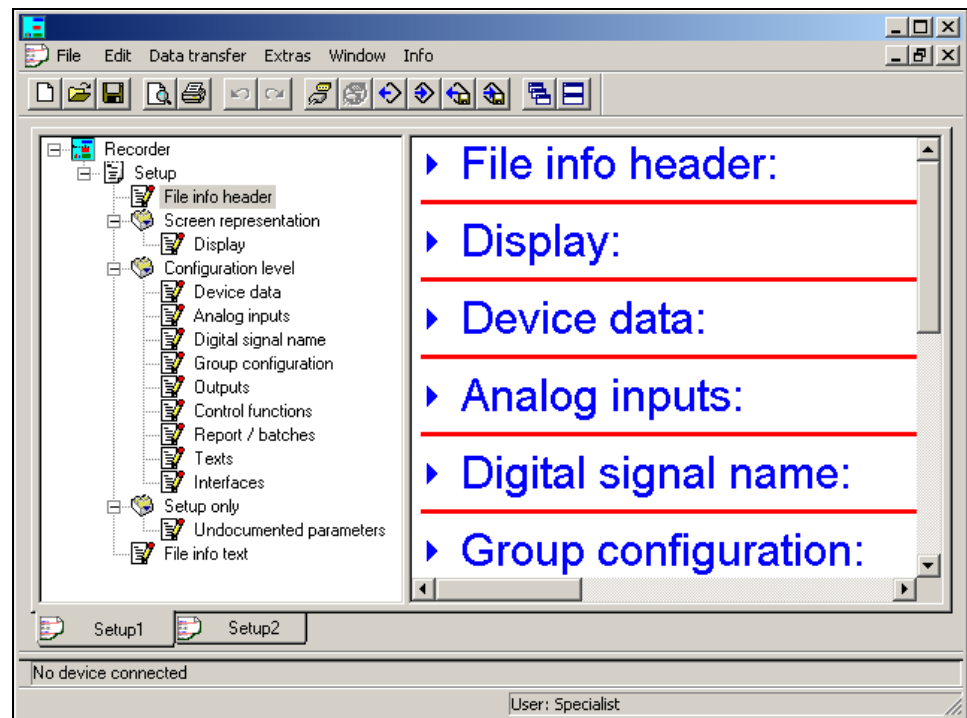

### Functions of the right mouse button

If you use the right mouse button in the dialog window, different functions will be available. These functions concern that part of the configuration on which the mouse pointer was positioned when using the right mouse button.

Example:

The right mouse button was used on the entry “Analog inputs”.

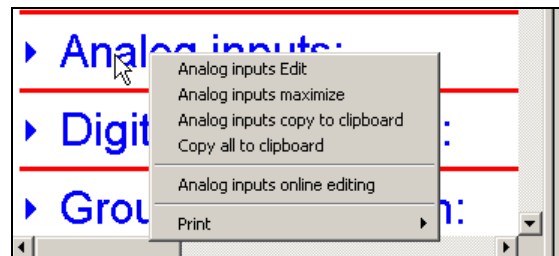

### Editing the analog inputs

The function starts the change dialog for configuring the analog inputs. Alternatively, configuring can also be started by a double-click with the left mouse button.

### Maximizing the analog inputs

This function prompts the display of the current configuration of the analog inputs. Alternatively, the current configuration can also be displayed by a click (left mouse button) on the “Arrow pointing to right” (▶).

### Analog inputs to clipboard

The function copies the current configuration of the analog inputs to the Windows clipboard. The contents of the clipboard can, for instance, be imported to an editor or a text processing program.

### **Copy all to clipboard**

This function copies the complete current configuration - not just that of the analog inputs - to the Windows clipboard. The contents of the clipboard can, for instance, be imported to an editor or a text processing program.

### **Online editing of the analog inputs**

The current setting of the analog inputs are directly read out from the device and the change dialog opens. Now you can alter the configuration. After alteration, the new setting is transmitted back to the device and entered in the dialog window.

If necessary, additional information that is required will be read out from the instrument and also entered in the dialog window. For instance, when editing the analog inputs online, the device data will also be read out from the device.

### **Printing**

This function enables the print-out of the latest setting. You can select which parameter groups are printed out, and which are not. Alternatively, printing out can also be carried out via the *File* menu.

# 5 Setup software

## 5.5 Teleservice

Using the Teleservice, you can poll the latest data of a recorder. In addition, the external logic inputs and the Modbus flag can be switched (activated).

⇒ You will find further information about the external logic inputs and the status flag in Chapter 2.4 “Digital signals”

In order to use Teleservice, there must be an existing connection to a device.

⇒ Chapter 5.7 “Connection between the PC and the recorder”

Via the *Window* menu, you can switch Teleservice into or out of display.

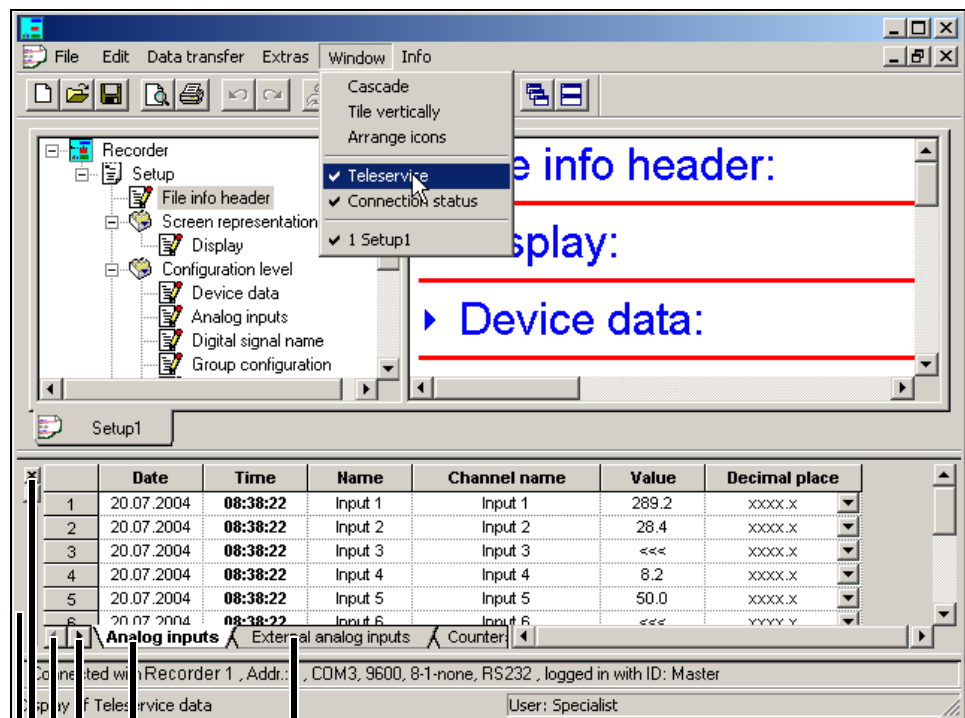

Click here to select the register as the active register

Active register

Click here to switch further registers into display (if available)



Close Teleservice window

Shift the Teleservice window

⇒ “Shifting the toolbar” on page 92

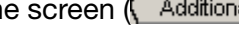

## Setting the Modbus flag

- \* With the left mouse button, repeatedly click on the arrow pointing to the right (  \ **Analog inputs**  ), until the register “Additional logic signals” appears on the screen (  ).
- \* Click on the register “Additional logic signals”. This automatically turns it into an active register.

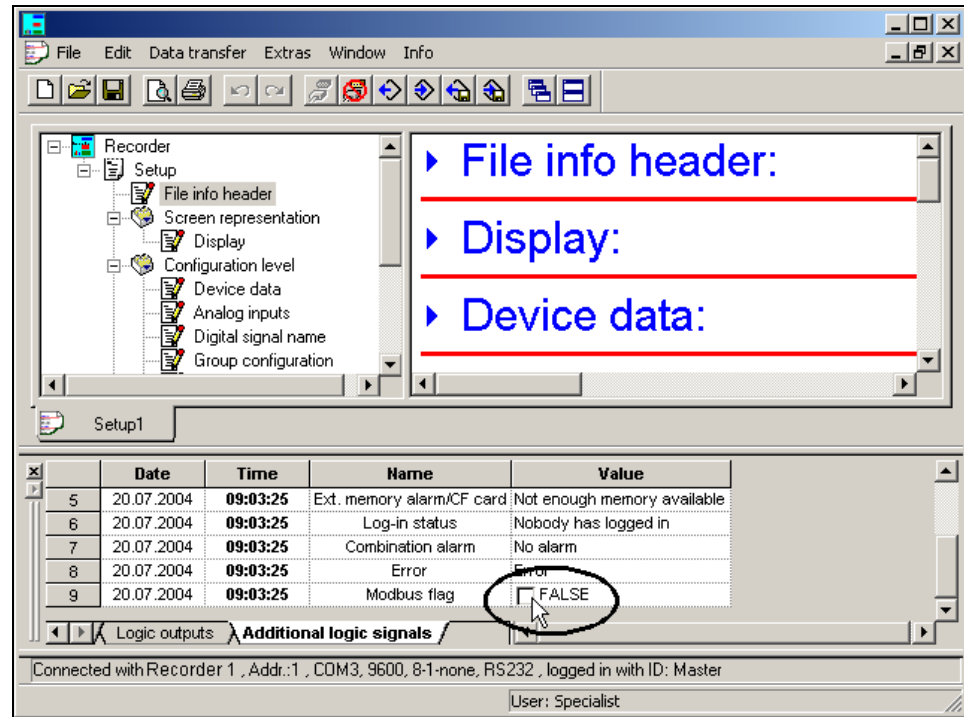

- \* Clicking on the box using the left mouse button (single click) will switch the Modbus flag.

## External logic inputs

The external logic inputs can also be switched using the setup software. The procedure corresponds to that when switching the Modbus flag.

## Shifting the Teleservice window

The Teleservice window, too, can be shifted. The same possibilities apply as for the shifting of the toolbar.

⇒ “Shifting the toolbar” on page 92

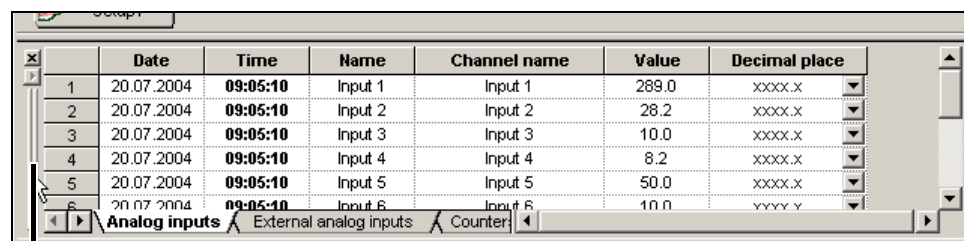

Position the mouse pointer here, and, holding the left mouse button down, shift the Teleservice window to a different position.

# 5 Setup software

## 5.6 Data transfer from and to the device

There are two ways of transferring the setup data to or from a recorder:

- transfer via the CompactFlash memory card and
- transfer via interface.

### 5.6.1 Transfer via CompactFlash memory card

In order to be able to read or write to CompactFlash memory cards from a PC, you will need a reader/writer.

When you have installed the reader/writer and have inserted a CompactFlash memory card, you will automatically have a new disk drive under Windows. You can use the new disk drive just like a normal hard disk using the Windows Explorer.

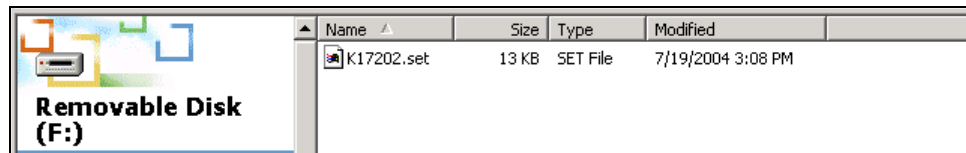

CompactFlash memory cards may only be removed from the reader/writer if the function "Eject removable medium" (function of the PC operating system) is executed first.

#### Paperless recorder

You can write setup data to the CompactFlash memory card, or read from it, using the recorder.

⇒ Chapter 3.6 "CompactFlash card"

#### Setup software

Use the toolbar or the *Data transfer* menu with its functions "Data export to CompactFlash" and "Data import from CompactFlash" in order to transfer the setup data.



Data import from CompactFlash

Data export to CompactFlash

## 5.6.2 Transfer via interface

Data transfer via interface is possible via one of the following interfaces:

Paperless recorder	PC
Setup interface	RS232C
RS232C	RS232C
RS422 / 485	RS422/485 (plug-in card or converter)
Ethernet	Ethernet

⇒ The setting for the interface parameter can be found in Chapter 4.2 “Table of configuration parameters”.

### Setup - RS232C

You will need the interface cable (including adapter) here. It is available as an accessory to the recorder.

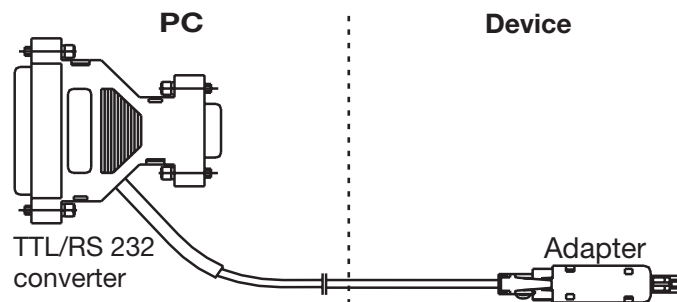

### RS232C

⇒ For the pin assignment, please refer to the Interface Description 9499-040-76311.

### RS422/485

⇒ For the pin assignment, please refer to the Interface Description 9499-040-76311.

### Ethernet

The recorder or the PC can be connected to the network using the usual network cables (RJ45 connector). If the recorder and a PC are to be directly connected, please use a crossover cable.



Only one 1 PC (client) at a time can access the device (server) via the Ethernet interface.

### Starting the transfer

Use the toolbar or the *Data transfer* menu with its functions “Data export to device” and “Data transfer from device” in order to transfer the setup data.

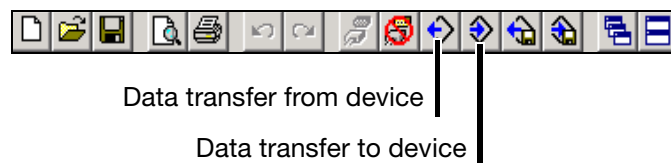

# 5 Setup software

## 5.7 Connection between the PC and the recorder

If data are to be exchanged between a recorder and a PC, it is essential to define which device and which route is used for communication, and establishing the connection to the device.

Connection to a device is made by using the function *Data transfer* → *Establish connection* or by a click on the  symbol.



If a connection has been established (communication is taking place) between the setup software and a device, then no other software component (e.g. PCC) can access this device.

### 5.7.1 Assistant for Device Settings

If there has never been any previous communication with a device, the “Assistant for Device Settings” will automatically be started when the first attempt at communication is made. This helps you to set up a device list.

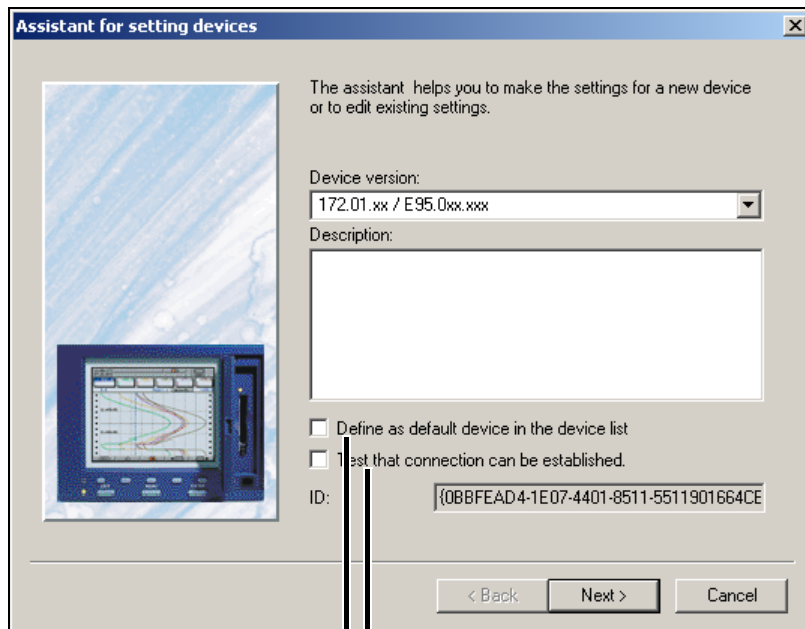

If the option is active () , a check is made at the end whether the chosen device can be accessed via the selected interface.

Here you can choose whether the device should be defined as the default device (). The system will automatically access a default device, other devices must be linked through the device list.

- \* First select the device version.
- \* Enter an additional description, if appropriate.
- \* Set one of the option fields, if appropriate.
- \* Press the  button.

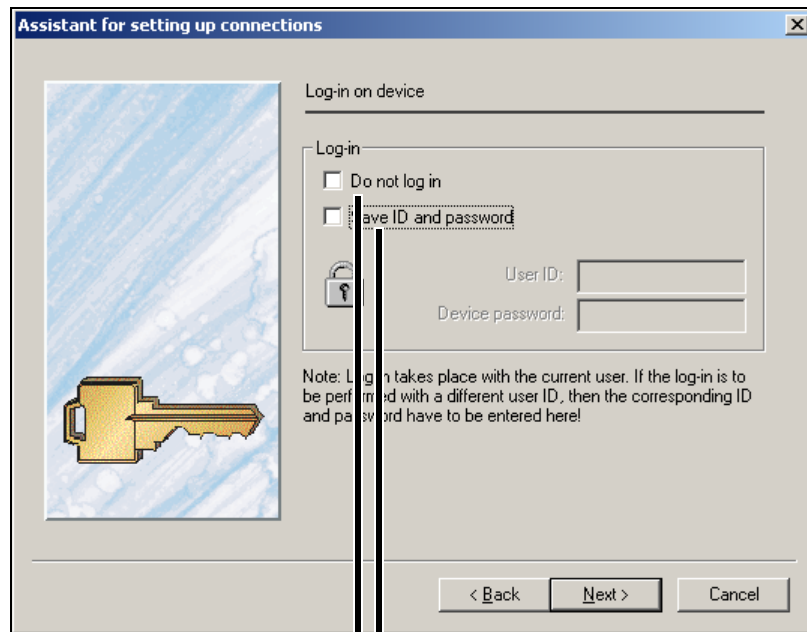

Save ID and password

Do not log in

### No log-in

The default setting of the setup software is that a user who is logged in is automatically logged in to a device that is found with the user's name and password, and can thus communicate with the device.

Set the option () if you do not want to log in. Please note that it is possible that some functions, such as Teleservice, will not be operable if you are not logged in. The decisive factor is the current user list and the access rights that are defined in the list.

### Saving ID and password

If the option is active, the log-in is made to the device which has the user ID and password that are entered, regardless of the actual user of the setup software.

- \* Press the  button.
- \* In the following dialog window, select the interface which you want to use to access the device. Available options are:

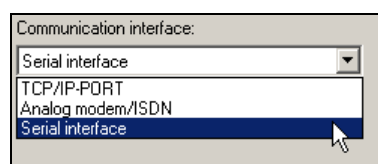

## 5 Setup software

---

The next steps depend on which interface or type of connection has been selected.

### TCP/IP PORT

The following parameters must be selected.

IP address / HOST name	xxx.xxx.xxx.xxx (Example: 10.11.2.100)	Enter the IP address of your device. If you enter the name, the IP address can be determined by clicking on the button "Convert HOST name to IP address".
Port number, port name	502	The port used for communication.
Communication protocol	Modbus TCP/IP, Modbus protocol	Modbus TCP/IP must be set here.

### Analog modem / ISDN

The following parameters must be selected.

Telephone number		Enter the telephone number for the required device.
Connect via		Select the modem that is to be used to make the connection.
Communication protocol	Modbus TCP/IP, Modbus protocol	Modbus protocol must be set here.
Device address	1 – 255	Device address for the Modbus protocol.

## 5 Setup software

### Serial interface

The following parameters must be selected.

Connected to	COM1, COM2	The PC interface to which the paperless recorder is connected.
Transmission rate	9600, 19200, 38400	The transmission rate must match the one that has been set in the device.
Control signal	RS232	If the RS232 interface on the device is used.
	RS232 setup interface (TTL)	If the setup interface on the device is used.
	RS422-RTS	If the RS422/485 interface on the device is used.
	RS422-DTR	
	RS485-RTS	
RS485-DTR		
Communication protocol	Modbus TCP/IP, Modbus protocol	Set the Modbus protocol here.
Device address	1 – 255	Device address for the Modbus protocol. If “RS232 setup interface” is used as a control signal, the device address will be ignored. It need not match the address in the device.

### Device list

When all settings have been made, the device is entered in the device list.

# 5 Setup software

## 5.7.2 Device list

All devices that have been defined are shown in a device list. The interface parameters are also administered her, and new, additional devices can also be defined in the device list.

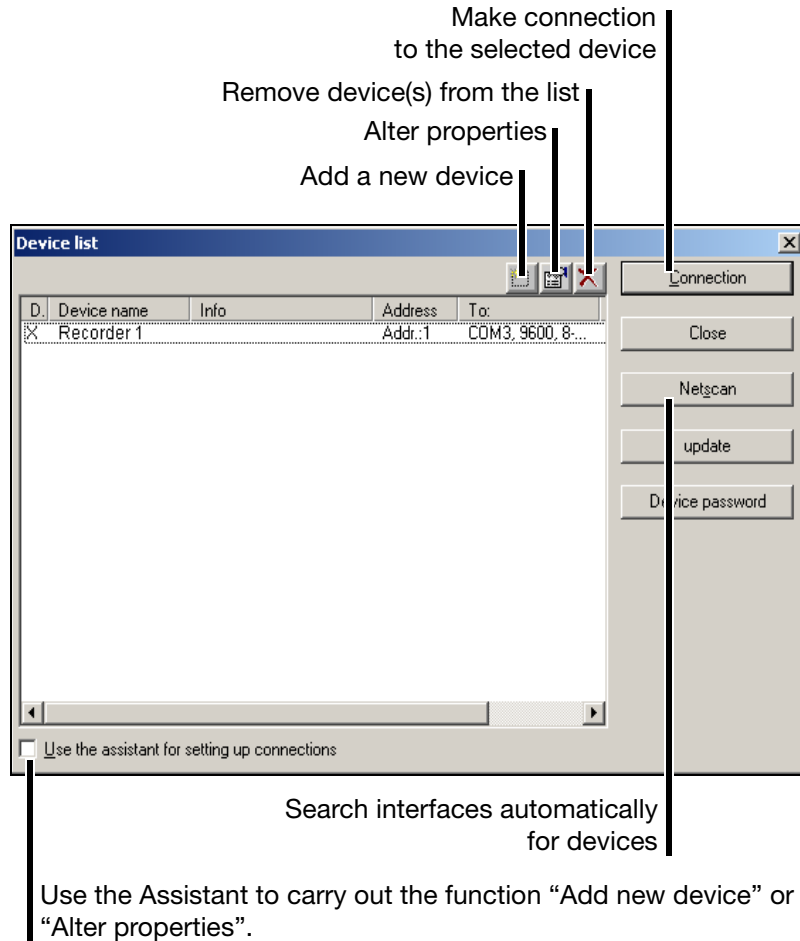

Use the **Connection** button to make a connection to a device. By using the Ctrl key on the PC keyboard and the left mouse button, you can select several devices at one time (only for deleting devices from the device list).

A successful connection produces a change in the toolbar.

### Not connected



### Connected





### 5.7.3 Incorrect log-in to device

If you want to access a device from within the setup software, it is possible that you will be unable to log in to the device. Probably, you are not registered as a user (incorrect device-rights file), or PC and device password do not match, or the device password has expired (remedy: alter password).

#### Incorrect log-in

The picture below shows an example of a possible error message:

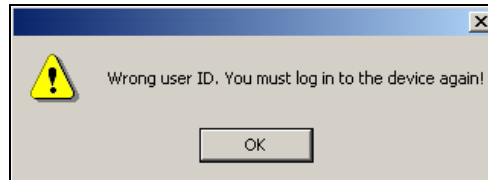

\* Confirm the error message by pressing the  button.

A dialog window now appears, in which you can log in to a device by using a valid device-user ID.



Save ID and password.

#### Save ID and password to device list

If you set the option () , the ID and password will be saved, and then automatically transmitted to the device when the next connection is made.

⇒ See "Saving ID and password" on page 101.

You can delete the ID and the password from the device list via the device list (properties of a connection).

# 5 Setup software

---

## 5.8 Menu functions

### 5.8.1 File

<b>New</b>	Opens a new setup in the working area. The values will be preset to the factory default settings.
<b>Open</b>	Opens an existing setup from a file, and present the contents in the working area.
<b>Save</b>	Save the setup that is shown in the working area to a file. It is only necessary to enter the file name once. If the file is saved again, no query is made about the file name.
<b>Save as</b>	Save the setup that is shown in the working area to a file. Unlike the <i>Save</i> function, this always asks for a file name.
<b>Close</b>	Removes a complete setup from the working area. If changes have not yet been saved, this can still be done immediately after calling up the <i>Close</i> function.
<b>Delete</b>	Deletes a file from a hard disk or another type of data storage medium.



Deleted files cannot be recovered !

<b>Export as RTF text</b>	The entire current configuration is saved as an RTF file. The RTF file can be opened by most word processing programs.
<b>Print</b>	When you have called up the function, the selection of what is to be printed appears first. Printing starts when the selection has been concluded.
<b>Print preview</b>	The printed result is displayed on the screen. You can let several pages be displayed, and alter the size of the pages on the screen.
<b>Printer setup</b>	Here you can make alterations to the settings for your printer. When the program is started, the standard printer for Windows will always be set as the active printer.
<b>Default settings</b>	Here you can make alterations to the default settings for the program. The alterations will only take effect after a fresh start of the setup software.
<b>Exit</b>	This closes down the setup software.

### 5.8.2 Editing

**Undo ...** Undoes the last editing action. In the menu, the setting that is being undone is shown behind *Undo*.

**Restore ...** The *Restore* function is only available if the *Undo* function has been called up. This function is used to restore the setting that was deleted with *Undo*.

**Parameterization** This function is activated by double-clicking (left mouse button) on the following function in the dialog window.

---

▶ **Display:**

---

**Configuration level** This function is activated by double-clicking (left mouse button) on one of the following functions in the dialog window.

---

▶ **Device data:**

---

▶ **Analog inputs:**

---

▶ **Digital signal name:**

---

▶ **Group configuration:**

---

▶ **Outputs:**

---

▶ **Control functions:**

---

▶ **Report / batches:**

---

▶ **Texts:**

---

▶ **Interfaces:**

---

**Settings via Setup only** This function is activated by double-clicking (left mouse button) on the following function in the dialog window.

---

▶ **Undocumented parameters:**

---

**Setup data info** This function is activated by double-clicking (left mouse button) on one of the following functions in the dialog window.

---

▶ **File info header:**

---

▶ **File info text:**

---

## 5 Setup software

---

### 5.8.3 Data transfer

<b>Make connection</b>	This function establishes a connection to a device. A connection to a device is a precondition for transferring a setup to or from a device via an interface (serial or Ethernet).
<b>Break connection</b>	Breaks an existing connection. A connection to a device must be broken before a new connection can be established to another device.
<b>Data transfer to device</b>	Transmits a setup to a device.
<b>Data transfer from device</b>	Reads in a setup from a device. If there is no connection, the software will automatically attempt to access the default device.
<b>Data export to CF card</b>	The setup will be saved on a CompactFlash card. The CompactFlash card can be read by the device.
<b>Data import from CF card</b>	Reads a setup from a CompactFlash card, and displays it in the working area.

### 5.8.4 Extras



All the functions in the *Extras* menu which require access to a device must have a connection to the device. If there is no connection, the setup software will try to access the default device from the device list. If no default device has been defined, then the device list will appear on the screen and the user must set up a connection by hand.

<b>Enable program options</b>	If no valid serial number was entered during the installation of a program, then it will only run in demo mode, and some functions, e.g. “save”, will be blocked. This function can be used to register a program at a later date and so change it from a demo version into a full version.
<b>Enable extra codes</b>	This function is intended for later extensions within the paperless recorder. After starting up the function, a code number must be read out from the device, using the <b>Read out code number</b> button, and then passed on to the manufacturer. The manufacturer will then produce a “release” number. The <b>Enable</b> button is used to transmit this release number to the device, which then enables the new device function.

### Create screenshot

This function (also known as “print screen”) is another option which is available for documenting settings or events.

Start the function and operate the “Create” button. A screenshot (print-out) will be created for the device that is connected. You can save the screenshot as a bitmap, or print it out directly.

### Date and time

This function is used to match the date and time for a PC and a device.

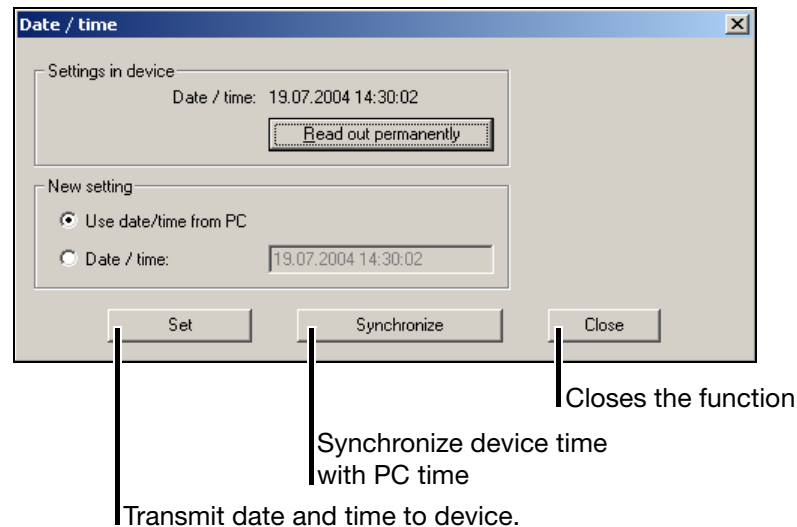

The new setting of the date and time of a device is made with the **Set** or **Synchronize** button. Both functions use the entries under “New setting” as the basis for making the setting.

The **Set** function sets the date and time of a device.

The **Synchronize** function only sets the time. If there is a deviation of more than 30 seconds, the function will not be performed.

The **Read out permanently** ensures that the device clock is read out permanently (cyclically). Permanent read-out must be terminated through **Cancel**. The device clock cannot be set during permanent read-out.

### Event counter

This function can be used to read out the two internal and the two external counters of the paperless recorder and set them to a specific value.

After starting up the function, a connection is made to a device and the current count is displayed. You can now alter the individual counts. If you click **OK**, the new counts will be adopted by the device.

## 5 Setup software

---

### Ethernet interface

This function transmits an Ethernet configuration to a device. It does not matter how the device is connected to the PC. Transmission via a serial interface is also possible.



If a device is already connected via an Ethernet link, then the function can be used to alter the Ethernet configuration in the device. The Ethernet data in the device list are now incorrect, i.e. you must now edit the device setting in the device list.

The Ethernet configuration is not controlled through the dialog window in the setup software, but only here, in the *Extras* menu.

### Write interface texts

This function can be used to transmit batch texts, recipes and a message text to a device.

Batch texts are used to describe a batch report. The batch texts can only be written, if the contents of the right column of a text has been configured as an interface text.

Recipes are used to describe a batch. Recipes can only be entered through the *Extras* menu, and then transmitted to a device. Recipe data are evaluated by the PC Evaluation Software PCA3000.

The message text can be used to make an entry in the event list for a device.

The functions are independent of the latest setting in the dialog window. The data can be transmitted to a device, without causing a new configuration.



In order to be able to write interface texts, rights exist on the device side, as well as on the PC side (special case).

The device right “Enter batch texts” is available in the device as a factory default right.

The message text for the event list also incorporates a right on the device side (“Write Teleservice (comments...)”).

### Password administration ...

This function can be used to alter the factory-set user administration for the recorder. You can alter the user names (master and user), the passwords („“ and 0) as well as the standard rights.

After starting the function, you can select how the data are to be transmitted to the recorder.

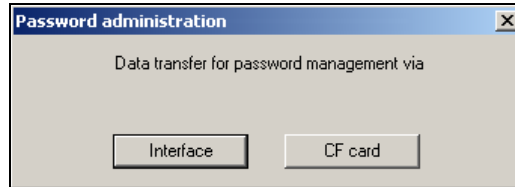

#### Interface

The data are read out from the recorder via an interface, can be modified and sent back to the recorder.

#### CF card

The data are read out from a file (P17201.SET), can be modified and stored in the file again. After selecting the drive or folder, a check is made whether the file already exists. If this is not the case, then a default file is generated. During processing, the file may be located in any folder. However, for a transfer to the recorder, it must be located in the main folder of a CompactFlash card. On the recorder, use the *CF card* → *User list* function in the *CompactFlash card* menu for transferring the password and rights file to the recorder.

When the transfer mode has been selected, the actual password administration can take place.

#### Password administration

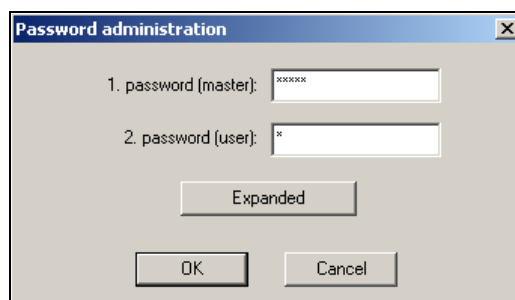

In the standard dialog, you can only change the two passwords for the users. If, however, you would also like to change the user names and their rights, you will first have to activate the **Expanded** button.

## 5 Setup software

---

### Expanded password administration

The rights of the user can be modified here.

The name of the user is shown in the selection list when logging in.

Additional name for display purposes

The screenshot shows a dialog box titled "Expanded password administration". It contains two sections for user configuration. The first section, "Password 1:", has a "User ID:" field with the value "Maste", a "User name:" field with the value "System-Master", and a "Rights:" button with three dots. The second section, "Password 2:", has a "User ID:" field with the value "User", a "User name:" field with the value "Data-Management", and a "Rights:" button with three dots. Below these sections is a "Standard rights" button. At the bottom of the dialog are "OK" and "Cancel" buttons.

The standard rights (rights that exist if nobody is logged in) can be modified here.

### Fresh log-in / alter password

Using the *Fresh log-in / Alter password* function, you can

- activate the user and password query at the program start and
- modify the current password.

This function is only relevant for the operation of the setup software, but not for the user list of the recorder.

#### Activating the user and password query at the program start

When the setup software is first newly installed, there will initially be no user name and password query at the program start. You are automatically logged in as "Specialist" with a blank password.

Proceed as follows:

Start the "Fresh log-in / Alter password" function



- \* Switch options into display.

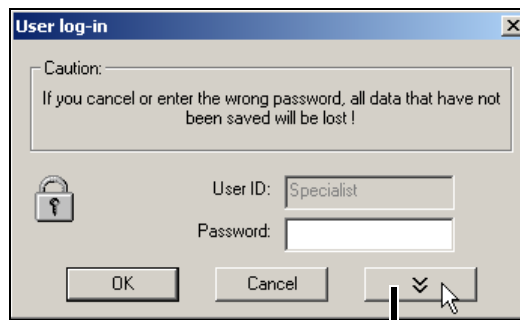

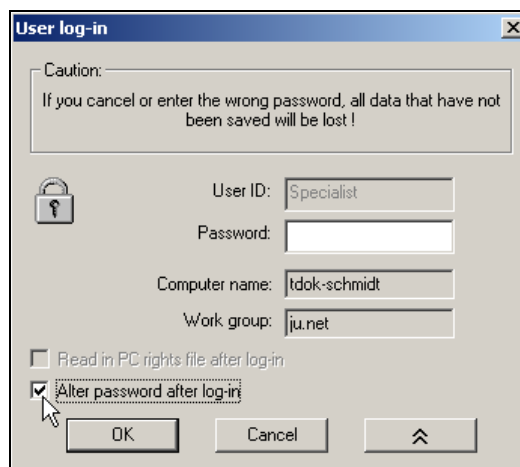

Show options

- \* Activate the option "After log-in, alter password" and click .

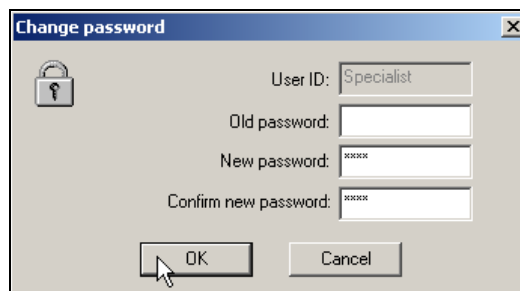

- \* Enter passwords - the "Old password" field remains empty.



When the entry has been completed, the new password is activated by clicking . From now on, the user name and password will be requested at the start of the program.



The start password is initially also not allocated to the "Maintenance" user. Log-in at the program start with the "Maintenance" user name and enter a password as described above.

# 5 Setup software

---

## Altering the password

Altering a password corresponds to activating the password administration, with the difference that the “Old password” field must not be left empty.

### 5.8.5 Window



The usual Windows options are available for the positioning of the dialog windows.

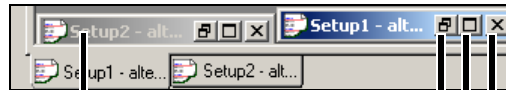

Enlarging and minimizing

Reducing and maximizing

Close

A double-click with the left mouse button produces maximum enlargement.

#### Cascade

If several dialog windows are open at the same time, this function has the effect that all windows are shown with an offset to one another. A double-click with the left mouse button brings a window into the foreground.

#### Tiled horizontally

If several dialog windows are open at the same time, this function has the effect that the various windows are shown one above another. A double-click with the left mouse button in a window makes that window active.

#### Arrange icons

All open windows are minimized – they disappear from the screen, but are not closed.

#### Teleservice

You can switch Teleservice into or out of display by using this function. The position is independent of the position of the dialog window.

⇒ Chapter 5.5 “Teleservice”

#### Connection status

Ein Aufruf der Funktion blendet wechselweise das Verbindungsstatus-Fenster ein und aus. Die Positionierung ist unabhängig von der Positionierung des Dialogfensters.

⇒ See “Connection status” on page 92.

### 5.8.6 Info

- Info on Setup** Here you can find out the version number of the setup software. Please have the version number available if you contact the service hotline.
- Registered license numbers** Here you can find out the license number of the setup software. Please have the license number available if you contact the service hotline.
- Program folder** Here you can obtain information as to which folders (directories) on the hard disk or in the network are used by the setup software. If you operate the  button, the contents of the folder will be displayed.

# 5 Setup software

## 5.9 Character set

032		080	P	0162	¢	0210	Ò
033	!	081	Q	0163	£	0211	Ó
034	"	082	R	0164	¤	0212	Ô
035	#	083	S	0165	¥	0213	Õ
036	\$	084	T	0166	¦	0214	Ö
037	%	085	U	0167	§	0215	×
038	&	086	V	0168	¨	0216	Ø
039	'	087	W	0169	©	0217	Ù
040	(	088	X	0170	ª	0218	Ú
041	)	089	Y	0171	«	0219	Û
042	*	090	Z	0172	¬	0220	Ü
043	+	091	[	0173	-	0221	Ý
044	,	092	\	0174	®	0222	Þ
045	-	093	]	0175	¯	0223	ß
046	.	094	^	0176	°	0224	à
047	/	095	_	0177	±	0225	á
048	0	096	‘	0178	²	0226	â
049	1	097	á	0179	³	0227	ã
050	2	098	b	0180	´	0228	ä
051	3	099	c	0181	µ	0229	å
052	4	0100	d	0182	¶	0230	æ
053	5	0101	e	0183	·	0231	ç
054	6	0102	f	0184	¸	0232	è
055	7	0103	g	0185	¹	0233	é
056	8	0104	h	0186	º	0234	ê
057	9	0105	i	0187	»	0235	ë
058	:	0106	j	0188	¼	0236	ì
059	;	0107	k	0189	½	0237	í
060	<	0108	l	0190	¾	0238	î
061	=	0109	m	0191	¿	0239	ï
062	>	0110	n	0192	À	0240	ð
063	?	0111	o	0193	Á	0241	ñ
064	@	0112	p	0194	Â	0242	ò
065	A	0113	q	0195	Ã	0243	ó
066	B	0114	r	0196	Ä	0244	ô
067	C	0115	s	0197	Å	0245	õ
068	D	0116	t	0198	Æ	0246	ö
069	E	0117	u	0199	Ç	0247	÷
070	F	0118	v	0200	È	0248	ø
071	G	0119	w	0201	É	0249	ù
072	H	0120	x	0202	Ê	0250	ú
073	I	0121	y	0203	Ë	0251	û
074	J	0122	z	0204	Ì	0252	ü
075	K	0123	{	0205	Í	0253	ý
076	L	0124		0206	Î	0254	þ
077	M	0125	}	0207	Ï	0255	ÿ
078	N	0126	~	0208	Ð		
079	O	0161	j	0209	Ñ		

### Entering special characters

(Special) characters that cannot be input directly from the keyboard of the PC can be entered with the help of the **Alt** key and the numerical combinations that are specified in the table.

### Example

The special character © has to be entered:

- \* Position the cursor with the mouse, or by using the cursor keys, on the point where the character is to be inserted.
- \* Press the **Alt** key **and hold it down**
- \* Enter the number combination 0169 in the number block (on the right-hand side of the keypad) (the leading zero **must** be entered as well)
- \* Release the **Alt** key

The character © is inserted at the cursor position.



The character set depends on the language of the operating system used and may differ from the example.

# 5 Setup software

---

### 6.1 Rights regarding the PC Setup software

Depending on the installation and log-in, the individual users have different rights within the Setup software.

The differences are summarized in the table below.

<b>Right</b>	<b>Demo installation</b>	<b>Maintenance</b>	<b>Specialist</b>
Write interface texts	-	X	X
New	X	X	X
Open	X	X	X
Save, save as, delete	-	X	X
Configure undocumented parameters	-	-	X
Export to CF card	-	X	X
Import from CF card	-	X	X
Print	-	X	X
Enable program options	X	-	X
Enable extra codes	-	-	X
Edit interface settings	-	X	X
Edit device settings	X	X	X
Delete device	-	-	X
Create new device	X	-	X
X = right exists			

# 6 Rights

## 6.2 Rights regarding the paperless recorder

The following table lists the rights of the individual users with respect to the recorder.

Right	not logged in	User	Master
Setup			
Configure (device, CF card, interface)	-	-	X
Time setting (device, interface)	-	-	X
Fine calibration (on device)	-	-	X
Measurement data			
Fetch stored measurement data (CF card, interface)	-	X	X
Only read stored measurement data	-	X	X
View measurement data (on device)	X	X	X
View measurement data and evaluate history (on device)	X	X	X
Batches			
Enter batch texts (device, interface)	X	X	X
Teleservice			
Teleservice: read (also generate screenshot)	-	X	X
Teleservice: write (insert comments....)	-	X	X
Security			
Manage users (device, CF card, interface)	-	-	X
View event list (on device)	X	X	X
General			
Set parameters	X	X	X
X = right exists.			

The PC Setup software can be used to modify the two user names (master and user) as well as their passwords and rights and transfer them to the device.



### A

- Action (outputs) 81
- Active operating mode 24
- Address 86
- Alarm 17
- Alarm delay 78
- Alarms 77
- Analog inputs 73–76
  - external 18
  - internal 18
- Annual report 42, 85
- Arrangement of the documentation 8

### B

- Bar graph representation 39
- Batch report
  - Completed batch report 51
  - Current batch report 49
- Batch reports 43
- Batch texts 48
- Batches 20, 42, 83
- Baud rate 86

### C

- Calibration status 70
- Cascade 114
- CF card (external) 72
- Channel description 40–41, 74–75
- Channel line 14, 17
- Channel name 40–41, 74–75
- Character entry 65
- Character restriction 66
- Character selection 65
- Close 106
- Cold junction 73
- Color display 13
- Commissioning 7
- CompactFlash 9, 13–14, 17, 98
  - CF plugged in 19
  - Stolen CF 19
- CompactFlash card 59
- Connection circuit 73
- Connection status 92, 114
- Connection, break 108
- Connection, make 108
- Contents right column 84
- Continue search 38
- Contrast 52–53, 69

# 7 Index

---

- Control function 82–83
- Control signal 70, 80
- Control signal (counters) 22, 82
- Control signal (Ext.report/ batches) 84
- Control signal (outputs) 81–82
- Counters 20, 22, 56
  - Control signal 82
  - Counting direction 82
  - Start value 82
  - Text 82
- Counting direction (counters) 82
- Create screenshot 109

## D

- Daily report 42, 85
- Data
  - Evaluation 26
  - Read-out via interface 26
- Data export to CF card 108
- Data format 86
- Data import from CF card 108
- Data transfer from device 108
- Data transfer to device 108
- Date 52, 70
- Date and time 109
- Decimal place 75–76
- Default settings 106
- Deleting 106
- Device address 86
- Device name 71
- Diagram speed 24, 34–35
- Differential (hysteresis) 78
- Digital signal name 76
- Digital signals 19
- Display 13
- Display off 14, 52, 69
- Displays and controls 13

## E

- El. signature 86
- Electrostatic discharge (ESD) 7
- Enabling extra codes 108
- Enabling program options 108
- End temperature 74
- End time (timed operation) 81
- End value
  - Actual 70
  - Target 70
- Enter key 13, 15

- Error 64
- Error messages 64
- Ethernet interface 110
- Evaluation of measurement data 35–36
- Evaluation software 59
- Event counter 109
- Event definition 56
- Event list 56
- Event message 16
- Event operation 21, 24
  - Control signal 80
  - Priority 24
  - Storage cycle 80
  - Stored value 80
- Events 56
- Exit 106
- Exit key 13, 15, 28
- Export as RTF text 106
- External analog inputs 18
- External cold junction temperature 73
- External report 20, 42, 83
- External text 20, 83

## F

- Factory setting 72
- Falling below range 17
- Filter constant 74
- Fine calibration 52, 54, 70

## G

- Group configuration 77–81
- Group manager 33
- Group name 77
- Group or instrument (device) name 16
- Group status 77

## H

- High limit 41, 77
- History 36, 49, 51
- Horizontal diagram 35
- Horizontal diagram representation 35

## I

- Info on Setup 115
- Information 16
- Input signal (analog channel) 77

## 7 Index

---

Input signal (digital channel) 79  
Instrument (device) info 63  
Instrument documentation in printed form 8  
Instrument documentation in the form of PDF files 8  
Int.mem./read-out via CF 72  
Int.mem./ser.read-out 72  
Integrator 23  
Integrator time base 75–76  
Integrator unit 75–76  
Interfaces  
    Ethernet 86–87  
    PROFIBUS-DP 86  
    RS232/RS4xx 86  
    Texts 110  
Internal analog inputs 18  
Introduction 7

### K

Key inhibit 83  
Keys 11, 16

### L

Language 72  
Limit index 34  
Line width 77  
Linearization 73  
Logged-in user 30  
Logging in 30  
Logging in/off 28–29  
Logging off 31  
Log-in, fresh 112  
Low limit 41, 77

### M

Measurement normalization 87  
Measurement representation 79  
Memory alarm 19, 26, 72  
Memory display 52–53  
Menu key 13, 15, 28  
Modbus flag 19  
Monthly report 42, 85

### N

New 106  
No value found 38  
Normal operation 24

- Storage cycle 80
- Store status 80
- Stored value 80
- Note signs 10
- Numerical 1-channel representation 41
- Numerical representation 40

### O

- Open 106
- Operating modes 24
- Out of limit 39
- Outputs 20, 81–83
  - Action 81
  - Control signal 81–82

### P

- Parameterization 52
- Password 29, 32
- Password activation 112
- Password alteration 32, 114
- Password, altering 112
- Period (report) 85
- Periodic report 42, 83
- Power LED 13, 15
- Principle of configuration 55
- Print 106
- Printer setup 106
- PROFIBUS-DP 18, 86
- Program folder 115
- Protocol 86

### R

- Range
  - End 73
  - Start 73
- Recording capacity 25
- Registered license numbers 115
- Report 42, 83–85
  - Annual report 85
  - Daily report 85
  - External report 83
  - Monthly report 85
  - Period 85
  - Periodic report 83
  - Synchronization time 85
- Representation 11
- Resistance 73

## 7 Index

---

Returning 7  
Rights 29, 120

### S

Sales documentation in printed form 8  
Save 106  
Save as 106  
Scaling 34  
Scaling end 74–75  
Scaling start 74–75  
Screen saving 14, 52, 69  
Screen texts 11  
Search result 38  
Sensor 73, 75  
Serial interface 18  
Setup plug 14  
Setup software  
    Assistant for Device Settings 100  
    CompactFlash 98  
    Configuration 93  
    Current setup 93  
    Data transfer 98  
    Device list 104  
    External logic inputs 97  
    Hardware and software requirements 89  
    Incorrect log-in to device 105  
    Installation 90  
    Menu bar 91  
    Menu functions 106  
    Navigation tree 93  
    Program start 90  
    Setting the Modbus flag 97  
    Shifting the Teleservice window 97  
    Shifting the toolbar 92  
    Start preparations 90  
    Teleservice 92, 96  
    Toolbar 91  
    Transfer 98  
    User interface 91  
    Working area 92  
Signal types 19  
Softkey 13–16, 30, 36  
Speed 34–35  
Speed indication 52–53, 69  
Stainless steel front 15  
Standard text 56  
Start menu 28  
Start temperature 74  
Start time (timed operation) 81  
Start value

- Actual 70
- Target 70
- Start value (counters) 82
- Status indication of the digital channels 40
- Status LED 13, 15
- Status line 14, 16
- Status message 61
- Storage cycle 24, 80–81
- Store status 80
- Stored value 24, 80–81
- Summer time 71
- Supplementary text 57
- Supply frequency 72
- Switch-off event 69
- Synchronization time 42
- Synchronization time (report) 85

## T

- Teleservice 114
- Temperature unit 72
- Text (counters) 82
- Text (left column) 84
- Text editable? 85
- Text entry 65
- Text high alarm 78
- Text low alarm 78
- Texts 57, 86
- Tile horizontally 114
- Time 52, 70
- Time & Date 16
- Time synchronization 83
- Time zone 72
- Timed operation 24
  - End time 81
  - Start time 81
  - Storage cycle 81
  - Stored value 81
- Typographical conventions 10

## U

- Underrange 17
- Unit 74, 76
- Unit of measurement 34
- User
  - Logged in 19
  - Logged-in user 16
  - Standard (default) password 29
  - Standard (default) user 29
- User administration 111

## 7 Index

---

Users *120*

### **V**

Value found *38*

Vertical diagram representation *34*

Visualization *33*

### **W**

Waiting time *69*

Warning signs *10*

Warranty *7*

Window technology *55*

Writing configuration data to CF card / reading from CF card *60*

Writing interface texts *110*

### **Z**

Zoom *37*









A5, geheftet, SW-Druck, Normalpapier 80g weiß

07.04/00437654

Subject to alterations without notice  
Änderungen vorbehalten  
Sous réserve de toutes modifications

© PMA Prozeß- und Maschinen-Automation GmbH  
P.O.B. 310 229, D-34058 Kassel, Germany  
Printed in Germany 9499-040-76111 (0501)a