

VARIO RTD 2

I/O Extension Module With Two Analog Input Channels for the Connection of Temperature Shunts (RTD)

User Manual

02/2003

57551001

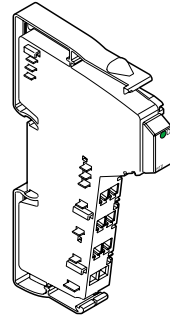

This data sheet is only valid in association with the documents of the used fieldbus coupler

Function

The VARIO RTD 2 terminal is designed for use within an VARIO station. This terminal provides a two-channel input module for resistive temperature sensors. This terminal supports platinum or nickel sensors according to the DIN standard and SAMA Directive. In addition, CU10, CU50, CU53, KTY81 and KTY84 sensors are supported.

The measuring temperature is represented by a 16-bit value in two data words (one word per channel).

Features

- Two inputs for resistive temperature sensors
- Configuration of the channels via fieldbus
- Measured values can be represented in 3 different formats.
- Connection of sensors in 2-, 3- and 4-wire technology

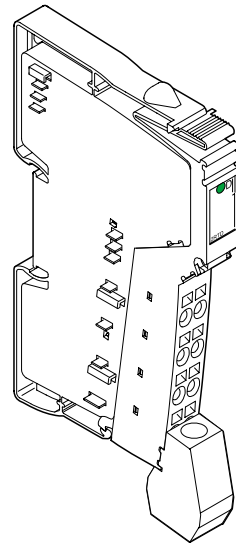

57550010

Figure 1 Terminal VARIO RTD 2 with connector fitted



All modules will be delivered including connectors and labeling fields

Table of Contents

Function	1
Safety Note	4
Installation Instructions	4
Internal Circuit Diagram	5
Electrical Isolation	6
Connection	6
Connection Examples	7
Programming Data	8
Process Data Words	8
Formats for Representing Measured Values	16
Measuring Ranges	22
Measuring Errors	24
Tolerance and Temperature Response	28
Technical Data	30
Ordering Data	32

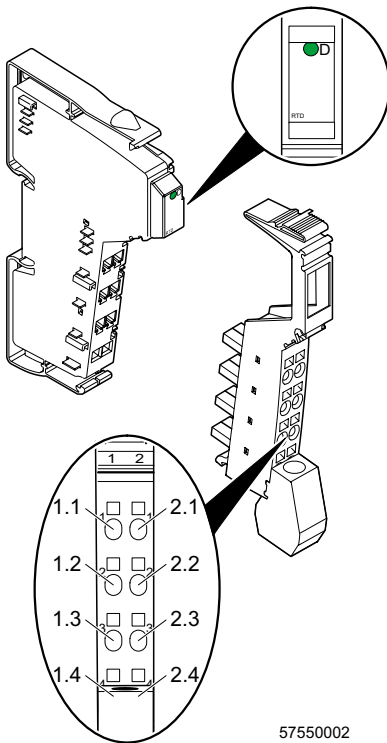

Figure 2 VARIO RTD 2 with the appropriate connector

57550002

Local Diagnostic and Status Indicators

Des.	Color	Meaning
D	Green	Bus diagnostics

Pin Assignment for 2- and 3-Wire Termination

Terminal Points	Signal	Assignment
1.1	I_{1+}	RTD sensor 1
1.2	I_{1-}	Constant current supply
1.3	U_{1-}	Measuring input sensor 1
2.1	I_{2+}	RTD sensor 2
2.2	I_{2-}	Constant current supply
2.3	U_{2-}	Measuring input sensor 2
1.4, 2.4	Shield	Shield connection (channel 1 and 2)

Pin Assignment for 4-Wire Termination on Channel 1 and 2-Wire Termination on Channel 2

Terminal Points	Signal	Assignment
1.1	I_{1+}	RTD sensor 1
1.2	I_{1-}	Constant current supply
1.3	U_{1-}	Measuring input sensor 1
2.3	U_{1+}	Measuring input sensor 1
2.1	I_{2+}	RTD sensor 2
2.2	I_{2-}	Constant current supply
1.4, 2.4	Shield	Shield connection (channel 1 and 2)



A sensor can only be connected to channel 1 using 4-wire technology.

Safety Note



During configuration, ensure that no isolating voltage is specified between the analog inputs and internal bus. This means that the user must provide signals with **safe isolation** for the thermistor detection, if required.

Installation Instructions

High current flowing through the potential jumpers U_M and U_S raises the temperature of the potential jumpers and the temperature inside the terminal. Observe the following instructions to keep the current flowing through the voltage jumpers of the analog terminals as low as possible:



Each of the analog terminals needs a separate main circuit!

If this is not possible in your application and if you are using analog terminals in a main circuit together with other terminals, place the analog terminals behind all the other terminals at the end of the main circuit.

Internal Circuit Diagram

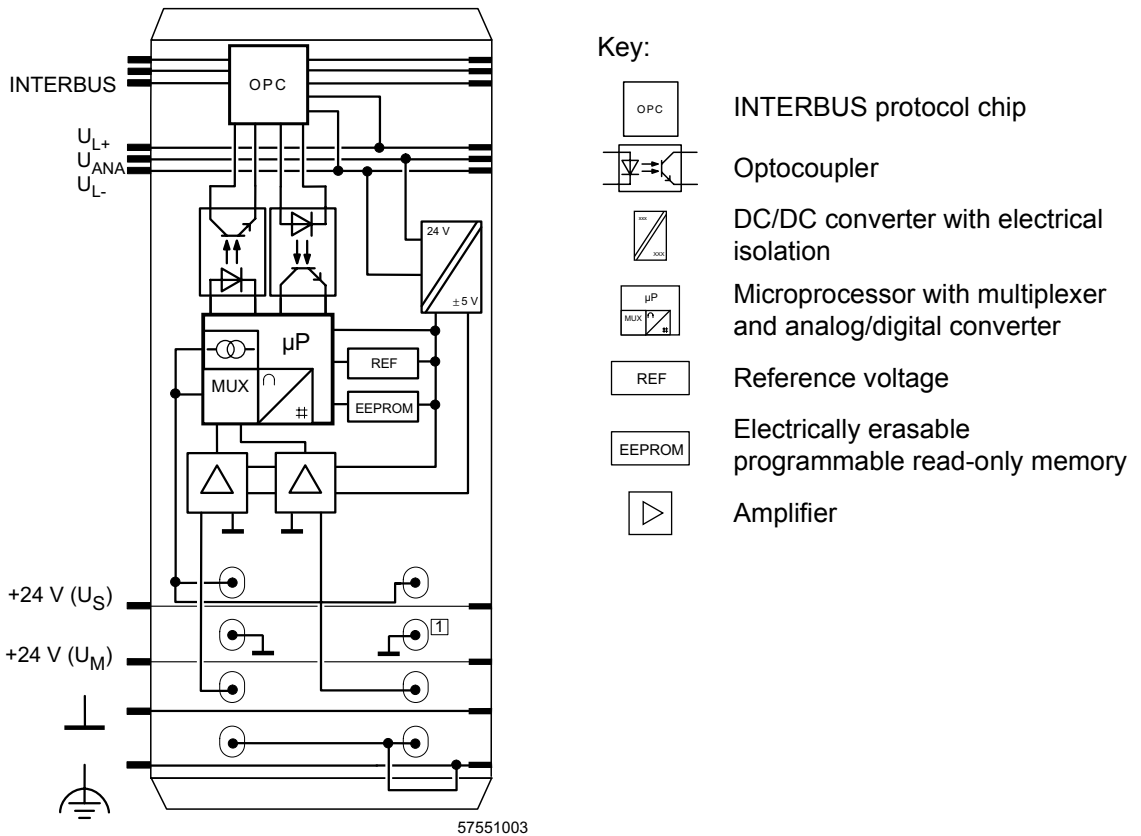

Figure 3 Internal wiring of the terminal points

Electrical Isolation



Bild 4 Electrical isolation of the single function areas

Connection

Connection of the Thermocouples

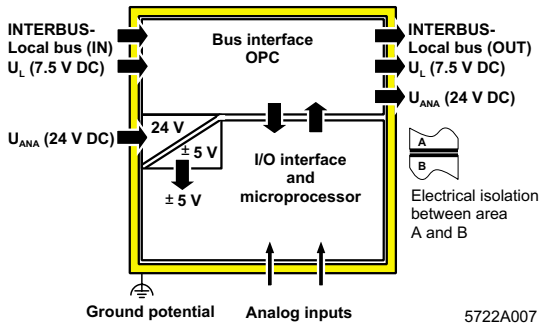

Always connect temperature shunts using shielded, twisted-pair cables.

Connection of the Shield



The connection of the shield is shown in the examples (Figure 5).

Connect the shielding of the Inline terminal using the shield connector clamp. The clamp connects the shield directly to FE on the terminal side. Additional wiring is not necessary.

Isolate the shield at the sensor.

Sensor Connection In 4-Wire Technology



A sensor can only be connected to channel 1 in 4-wire technology. In this case, the sensor on channel 2 can only be connected in 2-wire technology!

Connection Examples



When connecting the shield at the terminal you must insulate the shield on the sensor side (shown in gray in Figure 5 and Figure 6).

Use a connector with shield connection when installing the sensors. Figure 5 shows the connection schematically (without shield connector).

Connection of Passive Sensors

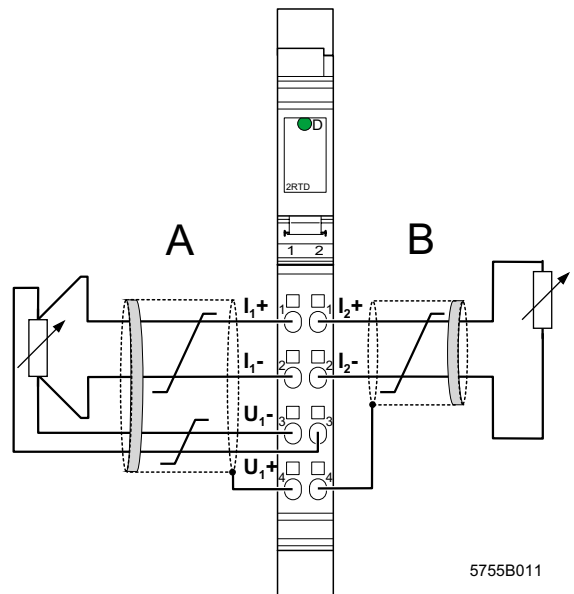
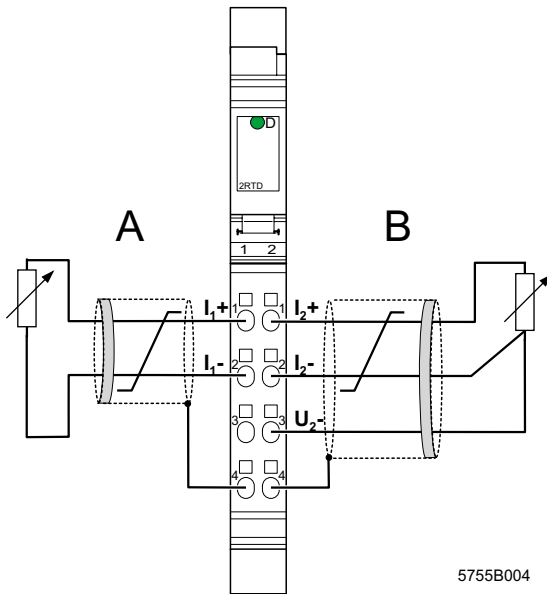

Figure 5 Sensor connections in 2- and 3-wire technology with shield connection

- A Channel 1; 2-wire technology
- B Channel 2; 3-wire technology

Figure 6 Sensor connections in 4-wire technology with shield connection

- A Channel 1; 4-wire technology
- B Channel 2; 2-wire technology

Programming Data

ID code	7F _{hex} (127 _{dec})
Length code	02 _{hex}
Input address area	4 bytes
Output address area	4 bytes
Parameter channel (PCP)	0 bytes
Register length (bus)	4 bytes

Process Data Words

Output Data Words for the Configuration of the Terminal (see page 11)

(Word.bit) view	Word	Word 0															
	Bit	15	14	13	12	11	10	9	8	7	6	5	4	3	2	1	0
(Byte.bit) view	Byte	Byte 0								Byte 1							
	Bit	7	6	5	4	3	2	1	0	7	6	5	4	3	2	1	0
Channel 1	Assignment	Configu- ration	Connection type	R ₀				Resol- ution	Format	Sensor type							

(Word.bit) view	Word	Word 1															
	Bit	15	14	13	12	11	10	9	8	7	6	5	4	3	2	1	0
(Byte.bit) view	Byte	Byte 2								Byte 3							
	Bit	7	6	5	4	3	2	1	0	7	6	5	4	3	2	1	0
Channel 2	Assignment	Configu- ration	Connection type	R ₀				Resol- ution	Format	Sensor type							

Assignment of the Terminal Points to the Input Data Word (see page 14)

(Word.bit) view	Word	Word 0															
	Bit	15	14	13	12	11	10	9	8	7	6	5	4	3	2	1	0
(Byte.bit) view	Byte	Byte 0								Byte 1							
	Bit	7	6	5	4	3	2	1	0	7	6	5	4	3	2	1	0
Terminal points channel 1	Signal	Terminal point 1.1: I_1+ sensor 1															
	Signal reference	Terminal point 1.2: I_1- sensor 1								Terminal point 1.3 U_1- sensor 1							
	Shield (FE)	Terminal point 1.4															

(Word.bit) view	Word	Word 1															
	Bit	15	14	13	12	11	10	9	8	7	6	5	4	3	2	1	0
(Byte.bit) view	Byte	Byte 2								Byte 3							
	Bit	7	6	5	4	3	2	1	0	7	6	5	4	3	2	1	0
Terminal points channel 2	Signal	Terminal point 2.1: I_2+ sensor 2															
	Signal reference	Terminal point 2.2: I_2- sensor 2								Terminal point 2.3 U_1+ sensor 2							
	Shielding	Terminal point 2.4															

Process Data Output Words

You can configure the channels of the terminal with the two process data output words. The following configurations are possible for every channel independent of the other channel:

- Sensor connection method
- Value of the R_0 reference resistance
- Setting the resolution
- Selection of the format for representing the measured values
- Setting the sensor type

The two channels are dependent on each other for the connection method. If the 4-wire mode is activated for channel 1, channel 2 can only be operated using the 2-wire connection method. The 4-wire connection method is only available for channel 1.

Configuration errors are indicated by the corresponding error code, as long as the IB standard format is configured as the format for representing the measured values.

The configuration setting is saved in a volatile memory. It must be transmitted in each INTERBUS cycle.

After the Inline station has been powered up, the message "Measured value invalid" (error code 8004_{hex}) appears in the process input words. After 1 s (maximum) the preset configuration is accepted and the first measured value is available.

Default:

Connection:	3-wire technology
R_0 :	100 Ω
Resolution:	0.1°C
Format:	Format 1 (IB standard)
Sensor type:	PT 100 (DIN)

If you change the configuration, the corresponding channel is re-initialized. The message "Measured value invalid" (error code $E8004_{\text{hex}}$) appears in the process data output words for 100 ms (maximum).

If the configuration is invalid, the message "Configuration invalid" appears (error code 8010_{hex}).



Please note that extended diagnostics is only possible if IB standard is configured as the format for representing the measured values. Since this format is preset on the terminal, it can be used straight away after power up.

One process data output word is available for the configuration of each channel.



Bild 7 Process data output words

VARIO RTD 2

Bit 15 and bit 14:

You must set bit 15 of the corresponding output word to 1 to configure the terminal or a certain channel. If bit 15 = 0 the preset configuration is active. Bit 14 is of no importance at present, therefore it should be set to 0.

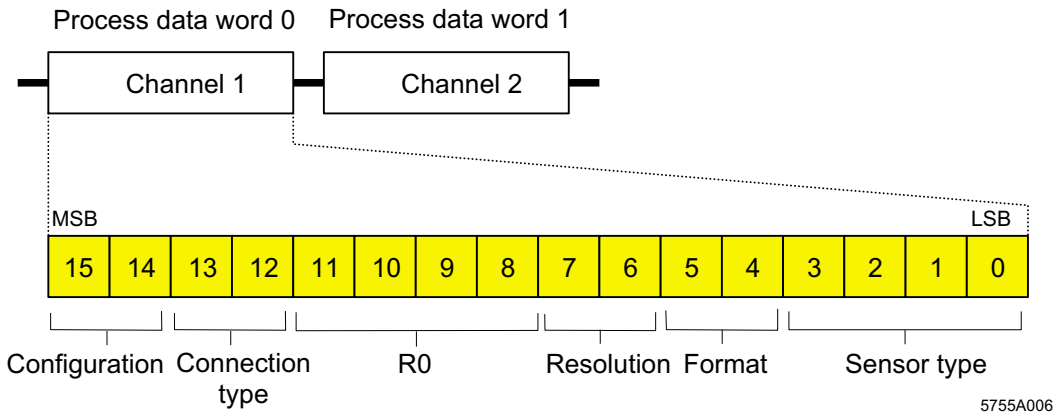
Bit 13 and bit 12:

Code		Connection Type
Dec.	Bin.	
0	00	3-wire
1	01	2-wire
2	10	4-wire (only channel 1)
3	11	Reserved

Bit 11 through bit 8

Code		R_0 [Ω]
Dec.	Bin.	
0	0000	100
1	0001	10
2	0010	20
3	0011	30
4	0100	50
5	0101	120
6	0110	150
7	0111	200

Code		R_0 [Ω]
Dec.	Bin.	
8	1000	240
9	1001	300
10	1010	400
11	1011	500
12	1100	1000
13	1101	1500
14	1110	2000
15	1111	3000 (adjustable)

Bit 7 and bit 6:

Code		Resolution for Sensor Type			
Dec.	Bin.	0 through 10	13	14	15
0	00	0.1°C	1%	0.1 Ω	1 Ω
1	01	0.01°C	0.1%	0.01 Ω	0.1 Ω
2	10	0.1°F	Reserved	Reserved	Reserved
3	11	0.01°F			

Bit 5 and bit 4:

Code		Format
Dec.	Bin.	
0	00	Format 1: IB standard (15 bits + sign bit with extended diagnostics) Compatible with ST format
1	01	Format 2 (12 bits + sign bit + 3 diagnostic bits)
2	10	Format 3 (15 bits + sign bit)
3	11	Reserved

Bit 3 through bit 0:

Code		Sensor Type
Dec.	Bin.	
0	0000	Pt DIN
1	0001	Pt SAMA
2	0010	Ni DIN
3	0011	Ni SAMA
4	0100	Cu10
5	0101	Cu50
6	0110	Cu53
7	0111	Ni 1000 (Landis & Gyr)

Code		Sensor Type
Dec.	Bin.	
8	1000	Ni 500 (Viessmann)
9	1001	KTY 81-110
10	1010	KTY 84
11	1011	Reserved
12	1100	Reserved
13	1101	Potentiometer [%]
14	1110	Linear R: 0 through 400 Ω
15	1111	Linear R: 0 through 4000 Ω

Process Data Input Words

The measured values are transmitted, per channel, through the process data input words to the controller board or the computer.

The three formats for representing the input data are shown in Bild 8. For more detailed information on formats, please refer to "Formats for Representing Measured Values" on page 16.



Bild 8 Sequence of the process data input words and representation of the bits of the first process data word in different formats

- MSB Most significant bit
- LSB Least significant bit
- SB Sign bit
- AV Analog value
- 0 Reserved
- OC Open circuit/short-circuit
- OR Over range

The "IB standard" process data format 1 supports extended diagnostics.
The following error codes are possible:

Code (hex)	Error
8001	Over range
8002	Open circuit or short-circuit (only available in the temperature range)
8004	Measured value invalid/no valid measured value available
8010	Configuration invalid
8040	Terminal faulty
8080	Under range

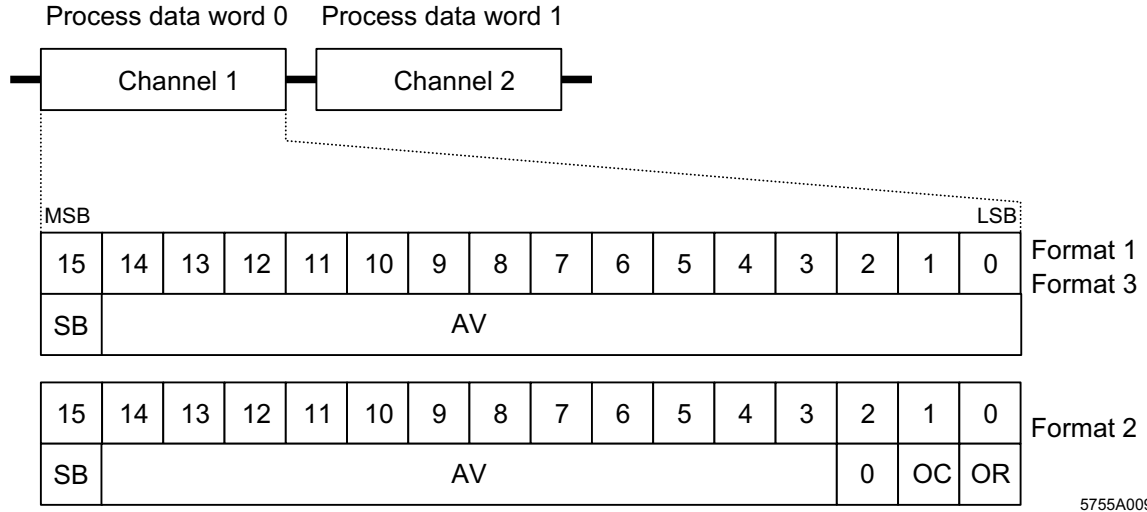
Open Circuit/Short-Circuit Detection:

Open circuit is detected according to the following table:

Faulty Sensor Cable	Temperature Measuring Range			Resistance Measuring Range		
	2-wire	3-wire	4-wire	2-wire	3-wire	4-wire
I+	Yes	Yes	Yes	Yes	Yes	No
I-	Yes	Yes	Yes	Yes	Yes	No
U+	–	–	Yes	–	–	Yes
U-	–	Yes	Yes	–	Yes	Yes

- Yes Open circuit/short-circuit is detected.
- The cable is not connected in this connection method.
- No Open circuit/short-circuit is not detected because the value is a valid measured value.

Formats for Representing Measured Values

Format 1: IB Standard (Default Setting)

The measured value is represented in bits 14 through 0. An additional bit (bit 15) is available as a sign bit.

This format supports extended diagnostics. Values $> 8000_{\text{hex}}$ indicate an error. The error codes are listed on page 15.

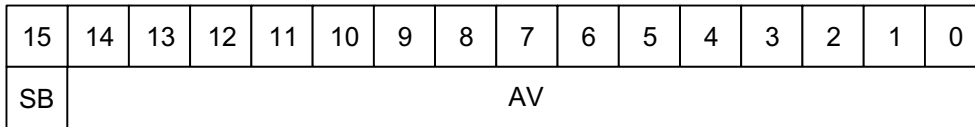

55641008

Bild 9 Measured value representation in format 1 (IB standard; 15 bits)

- SB Sign bit
- AV Analog value

Typical Analog Values Depending on the Resolution

Sensor Type (Bits 3 through 0)		0 through 10	13	14	15
Resolution (Bits 7 and 6)		$00_{\text{bin}} / 10_{\text{bin}}$	00_{bin}	00_{bin}	00_{bin}
Process Data (= Analog Value)		$0.1^{\circ}\text{C} / 0.1^{\circ}\text{F}$	1%	0.1Ω	1Ω
hex	dec	$[\text{C}] / [\text{F}]$	[%]	$[\Omega]$	$[\Omega]$
8002	–	Open circuit	–	–	–
8001	–	Over range (see page 23)	–	400	4000
2710	10000	1000.0	–	–	–
0FA0	4000	400.0	4000 ($40 \times R_0$)	400	4000
00A0	10	1.0	10 ($0.10 \times R_0$)	1.0	10
0001	1	0.1	1 ($0.01 \times R_0$)	0.1	1
0000	0	0	0	0	0
FFFF	-1	-0.1	–	–	–

Sensor Type (Bits 3 through 0)		0 through 10	13	14	15
Resolution (Bits 7 and 6)		$00_{\text{bin}} / 10_{\text{bin}}$	00_{bin}	00_{bin}	00_{bin}
Process Data (= Analog Value)		$0.1^{\circ}\text{C} / 0.1^{\circ}\text{F}$	1%	0.1Ω	1Ω
hex	dec	$[^{\circ}\text{C}] / [^{\circ}\text{F}]$	[%]	$[\Omega]$	$[\Omega]$
FC18	-1000	-100.0	–	–	–
8080		Under range (see table on page 23)	–	–	–
8002		Short circuit	–	–	–

Sensor Type (Bits 3 through 0)		0 through 10	13	14	15
Resolution (Bits 7 and 6)		$01_{\text{bin}} / 11_{\text{bin}}$	01_{bin}	01_{bin}	01_{bin}
Process Data (= Analog Value)		$0.01^{\circ}\text{C} / 0.01^{\circ}\text{F}$	0.1%	0.01Ω	0.1Ω
hex	dec	$[^{\circ}\text{C}] / [^{\circ}\text{F}]$	[%]	$[\Omega]$	$[\Omega]$
8002	–	Open circuit	–	–	–
8001	–	> 325.12 Over range (see page 23)	–	325.12	3251.2
2710	10000	100.00	1000.0 ($10 \times R_0$)	100.00	1000.0
03E8	4000	10.00	100.0 ($1 \times R_0$)	10.00	100.0
0001	1	0.01	0.1 ($0.01 \times R_0$)	0.01	0.1
0000	0	0	0	0	0
FFFF	-1	-0.01	–	–	–
D8F0	-10000	-100.00	–	–	–
8080		Under range (see page 23)	–	–	–
8002		Short-circuit	–	–	–



If the measured value is outside the representation area of the process data, the error message "Over range" or "Under range" is displayed.

Format 2

This format can be selected for each channel using bits 5 and 4 (bit combination 01_{bin}) of the corresponding process data output word.

The measured value is represented in bits 14 through 3. The remaining 4 bits are available as sign and error bits.

15	14	13	12	11	10	9	8	7	6	5	4	3	2	1	0
SB	AV											0	OC	OR	

55200060

Bild 10 Measured value representation in format 2 (12 bits)

SB	Sign bit
AV	Analog value
0	Reserved
OC	Open circuit/short-circuit
OR	Over range

Typical Analog Values Depending on the Resolution

Sensor Type (Bits 3 through 0)		RTD Sensor (0 through 13)	
Resolution (Bits 7 and 6)		$00_{bin} / 10_{bin}$	$01_{bin} / 11_{bin}$
Process Data (= Analog Value)		$0.1^{\circ}\text{C} / 0.1^{\circ}\text{F}$	$0.01^{\circ}\text{C} / 0.01^{\circ}\text{F}$
hex	dec	$[^{\circ}\text{C}] / [^{\circ}\text{F}]$	$[^{\circ}\text{C}] / [^{\circ}\text{F}]$
$\text{xxxx xxxx xxxx xxx}1_{bin}$		Over range (AV = positive final value from the table on page 23)	
2710	10000	1000.0	100.00
03E8	1000	100.0	10.00
0008	8	0.8	0.08
0000	0	0	0
FFF8	-8	-0.8	-0.08
FC18	-1000	-100.0	-10.00
$\text{xxxx xxxx xxxx xxx}1_{bin}$		Under range (AV = negative final value from the table on page 23)	
$\text{xxxx xxxx xxxx xx}1x_{bin}$		Open circuit/short-circuit (AV = negative final value from the table on page 23)	

AV Analog value

x Can have the values 0 or 1



If the measured value is outside the representation area of the process data, bit 0 is set to 1.

On an open circuit/short-circuit, bit 1 is set to 1.

Format 3

This format can be selected for each channel using bits 5 and 4 (bit combination 10_{bin}) of the corresponding process data output word.

The measured value is represented in bits 14 to 0. An additional bit (bit 15) is available as a sign bit.

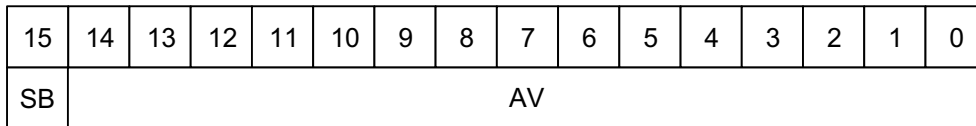

55641008

Bild 11 Measured value representation in format 3 (15 bits)

SB Sign bit AV Analog value

Typical Analog Values Depending on the Resolution

Sensor Type (Bits 3 through 0)		RTD Sensor (0 through 10)	Linear Resistance (15)
Resolution (Bits 7 and 6)		$00_{bin} / 10_{bin}$	00_{bin}
Process Data (= Analog Value)		$0.1^{\circ}\text{C} / 0.1^{\circ}\text{F}$	1Ω
hex	dec	$[^{\circ}\text{C}] / [^{\circ}\text{F}]$	$[\Omega]$
7FFF	32767	–	> 2048
Upper limit value* + 1 LSB		Over range	–
7D00	32000	–	2000
2710	10000	1000.0	625
000A	10	1	0.625
0001	1	0.1	0.0625
0000	0	0	0
FFFF	-1	-0.1	–
FC18	-1000	-100.0	–
Lower limit value* - 1 LSB		Under range	–
Lower limit value* - 2 LSB		Open circuit/short-circuit	–

Sensor Type (Bits 3 through 0)		RTD Sensor (0 through 10)	Linear Resistance (15)
Resolution (Bits 7 and 6)		$01_{bin} / 11_{bin}$	01_{bin}
Process Data (= Analog Value)		$0.01^{\circ}\text{C} / 0.01^{\circ}\text{F}$	0.1Ω
hex	dec	$[^{\circ}\text{C}] / [^{\circ}\text{F}]$	$[\Omega]$
7FFF	32767	–	> 4096
Upper limit value* + 1 LSB		Over range	–
7D00	32000	320.00	4000
2710	10000	100.0	1250
0001	1	0.1	0.125
0000	0	0	0
FFFF	-1	-1.0	–
D8F0	-10000	-100.0	–
Lower limit value* - 1 LSB		Under range	–
Lower limit value* - 2 LSB		Open circuit/short-circuit	–

* The limit values can be found on page 23.

Measuring Ranges

Measuring Ranges Depending on the Resolution (IB Standard Format)

Resolution	Temperature Sensors
00	-273°C to +3276.8°C Resolution: 0.1°C
01	-273°C to +327.68°C Resolution: 0.01°C
10	-459°F to +3276.8°F Resolution: 0.1°F
11	-459°F to +327.68°F Resolution: 0.01°F



Temperature values can be converted from °C to °F with this formula:

$$T [^{\circ}\text{F}] = T [^{\circ}\text{C}] \times \frac{9}{5} + 32$$

Where:

T [°F] Temperature in °F

T [°C] Temperature in °C

Input Measuring Ranges

No.	Input	Sensor Type	Measuring Range: (Software Supported)	
			Lower Limit	Upper Limit
0	Temperature sensors	Pt R ₀ 10 Ω to 3000 Ω Acc. to DIN	-200°C (-328°F)	+850°C (+1562°F)
1		Pt R ₀ 10 Ω to 3000 Ω Acc. to SAMA	-200°C (-328°F)	+850°C (+1562°F)
2		Ni R ₀ 10 Ω to 3000 Ω Acc. to DIN	-60°C (-76°F)	+180°C (+356°F)
3		Ni R ₀ 10 Ω to 3000 Ω Acc. to SAMA	-60°C (-76°F)	+180°C (+356°F)
4		Cu10	-70°C (-94°F)	+500°C (+932°F)
5		Cu50	-50°C (-58°F)	+200°C (+392°F)
6		Cu53	-50°C (-58°F)	+180°C (+356°F)
7		Ni 1000 L&G	-50°C (-58°F)	+160°C (+320°F)
8		Ni 500 (Viessmann)	-60°C (-76°F)	+250°C (+482°F)
9		KTY81-110	-55°C (-67°F)	+150°C (+302°F)
10	KTY84	-40°C (-40°F)	+300°C (+572°F)	
11	Reserved			
12				
13	Relative potentiometer range		0%	4 kΩ / R ₀ x 100% (400% maximum)
14	Linear resistance measuring range		0 Ω	400 Ω
15			0 Ω	4000 Ω



The number (No.) corresponds to the code of the sensor type in bit 3 through bit 0 of the process data output word.

Measuring Errors

Systematic Measuring Errors During Temperature Measurement With Resistance Thermometers

When measuring temperatures with resistance thermometers, systematic measuring errors are often the cause of incorrect measured results.

There are three main ways to connect the sensors: 2-, 3- and 4- wire technology.

4-Wire Technology

The 4-wire technology is the most precise way of measuring (see Figure 12).

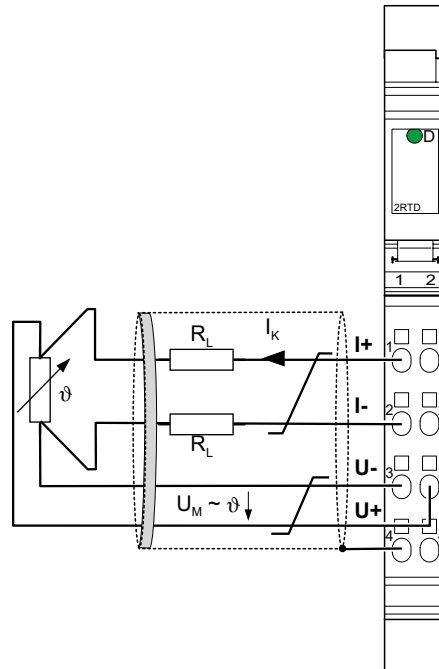

5755B012

Figure 12 Connection of resistance thermometers in 4-wire technology

In 4-wire technology, a constant current is sent through the sensor via the I+ and I- cables. Two further cables U+ and U- can be used to tap and measure the temperature-related voltage at the sensor. The cable resistances have absolutely no effect on the measurement.

3-Wire Technology

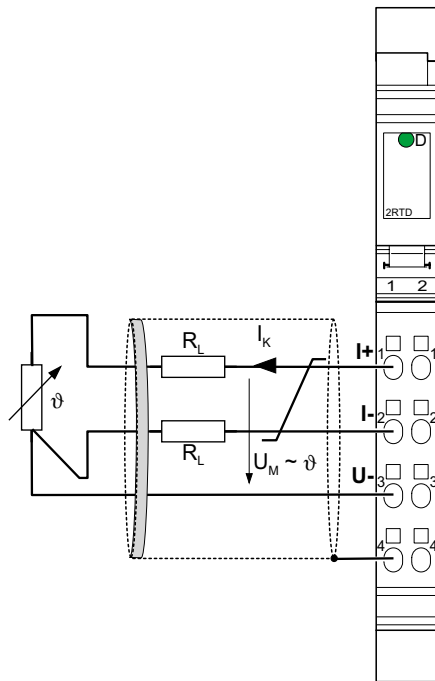

5755B018

Figure 13 Connection of resistance thermometers in 3-wire technology

In 3-wire technology, the effect of the cable resistance on the measured result in the terminal is eliminated or minimized by multiple measuring of the temperature-related voltage and corresponding calculations. The results are almost as good in terms of quality as with 4-wire technology in Figure 12. However, 4-wire technology offers better results in environments prone to interference.

2-Wire Technology

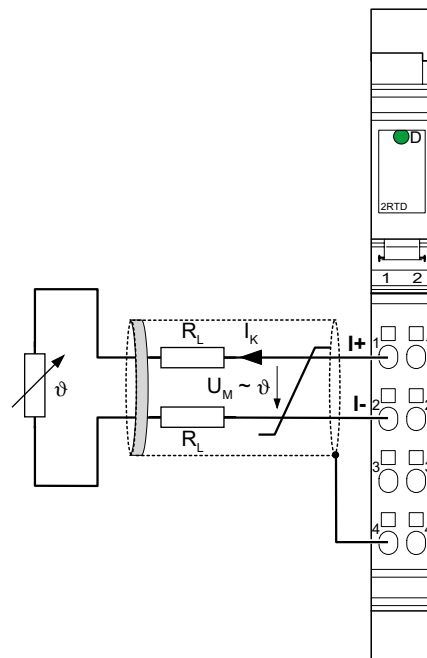

57550013

Figure 14 Connection of resistance thermometers in 2-wire technology

2-wire technology is a cost-effective connection method. The U+ and U- cables are no longer needed here. The temperature-related voltage is not directly measured at the sensor and therefore not falsified by the two cable resistances R_L (see Figure 14).

The measuring errors that occur can make the entire measurement unusable (see diagrams in Figure 15 to Figure 17). However, these diagrams also show the positions in the measuring system where steps can be taken to minimize these errors.

Systematic Errors During Temperature Measurement In 2-Wire Technology

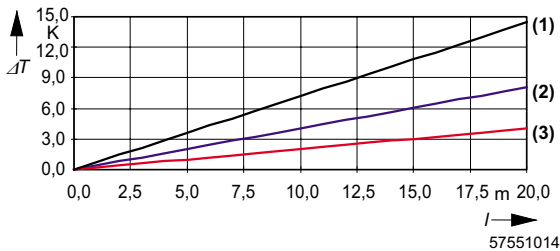

Figure 15 Systematic temperature measuring error ΔT depending on the cable length l

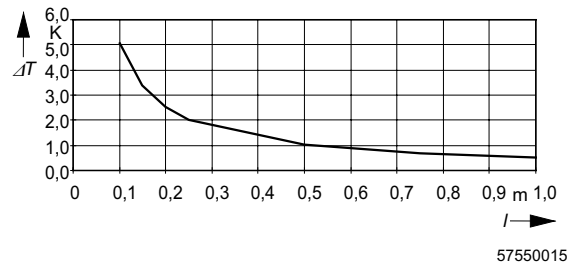

Figure 16 Systematic temperature measuring error ΔT depending on the cable diameter A

Curves depending on the cable diameter A

- (1) Temperature measuring error for A = 0.14 mm² (26 AWG)
- (2) Temperature measuring error for A = 0.25 mm² (24 AWG)
- (3) Temperature measuring error for A = 0.50 mm² (20 AWG)

(Measuring error valid for: copper cable $\chi = 57 \text{ m}/\Omega\text{mm}^2$, $T_U = 25^\circ\text{C}$ [77°F] and PT 100 sensor)

(Measuring error valid for: copper cable $\chi = 57 \text{ m}/\Omega\text{mm}^2$, $T_U = 25^\circ\text{C}$ [77°F], l = 5 m [16.404 ft.] and PT 100 sensor)

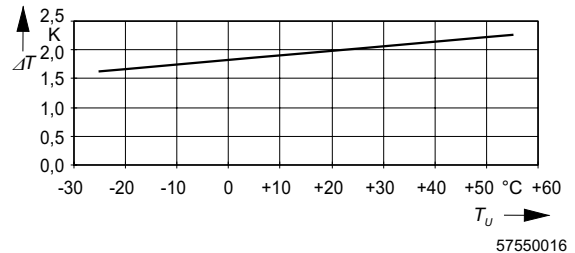

Figure 17 Systematic temperature measuring error ΔT depending on the T_U cable temperature

(Measuring error valid for: copper cable $\chi = 57 \text{ m}/\Omega\text{mm}^2$, l = 5 m [16.404 ft.], A = 0.25 mm² [24 AWG] and PT 100 sensor)

All diagrams show that the increase in cable resistance causes the measuring error.

A considerable improvement is made through the use of PT 1000 sensors. Due to the 10-fold higher temperature coefficient α ($\alpha = 0.385 \text{ } \Omega/\text{K}$ for PT100 to $\alpha = 3.85 \text{ } \Omega/\text{K}$ for PT1000) the effect of the cable resistance on the measurement is decreased by factor 10. All errors in the diagrams above would be reduced by factor 10.

Diagram 1 clearly shows the influence of the cable length on the cable resistance and therefore on the measuring error. The solution is to use the shortest possible sensor cables.

Diagram 2 shows the influence of the cable diameter on the cable resistance. It can be seen that cables with a diameter of less than 0.5 mm^2 (20 AWG) cause errors to increase exponentially.

Diagram 3 shows the influence of the ambient temperature on the cable resistance. This parameter does not play a great role and can hardly be influenced but it is mentioned here for the sake of completeness.

The equation for the calculation of the cable resistance is:

$$R_L = R_{L20} \times \left(1 + 0.0043 \frac{1}{K} \times T_U \right)$$

$$R_L = \frac{l}{\chi \times A} \times \left(1 + 0.0043 \frac{1}{K} \times T_U \right)$$

Where:

R_L	Cable resistance in Ω
R_{L20}	Cable resistance at 20°C (68°F) in Ω
l	Cable length in m
χ	Specific electrical resistance of copper in $\Omega\text{mm}^2/\text{m}$
A	Cable diameter in mm^2
0.0043 1/K	Temperature coefficient for copper
T_U	Ambient temperature (cable temperature) in $^\circ\text{C}$

Since there are two cable resistances in the measuring system (forward and return), the value must be doubled.

The absolute measuring error in Kelvin [K] is provided for platinum sensors according to DIN using the average temperature coefficient α ($\alpha = 0.385 \text{ } \Omega/\text{K}$ for PT100; $\alpha = 3.85 \text{ } \Omega/\text{K}$ for PT1000).

Tolerance and Temperature Response

Typical Measuring Tolerances at 25°C (77°F)

	α at 100°C (212°F)	2-Wire Technology		3-Wire Technology		4-Wire Technology	
		Relative [%]	Absolute	Relative [%]	Absolute	Relative [%]	Absolute
Temperature sensors							
PT 100	0.385 Ω /K	$\pm 0.03 + x$	$\pm 0.26 \text{ K} + x$	± 0.03	$\pm 0.26 \text{ K}$	± 0.02	$\pm 0.2 \text{ K}$
PT 1000	3.85 Ω /K	$\pm 0.04 + x$	$\pm 0.31 \text{ K} + x$	± 0.04	$\pm 0.31 \text{ K}$	± 0.03	$\pm 0.26 \text{ K}$
Ni 100	0.617 Ω /K	$\pm 0.09 + x$	$\pm 0.16 \text{ K} + x$	± 0.09	$\pm 0.16 \text{ K}$	± 0.07	$\pm 0.12 \text{ K}$
Ni 1000	6.17 Ω /K	$\pm 0.11 + x$	$\pm 0.2 \text{ K} + x$	± 0.11	$\pm 0.2 \text{ K}$	± 0.09	$\pm 0.16 \text{ K}$
Cu 50	0.213 Ω /K	$\pm 0.24 + x$	$\pm 0.47 \text{ K} + x$	± 0.24	$\pm 0.47 \text{ K}$	± 0.18	$\pm 0.35 \text{ K}$
Ni 1000 L&G	5.6 Ω /K	$\pm 0.13 + x$	$\pm 0.21 \text{ K} + x$	± 0.13	$\pm 0.21 \text{ K}$	± 0.11	$\pm 0.18 \text{ K}$
Ni 500 Viessmann	2.8 Ω /K	$\pm 0.17 + x$	$\pm 0.43 \text{ K} + x$	± 0.17	$\pm 0.43 \text{ K}$	± 0.14	$\pm 0.36 \text{ K}$
KTY 81-110	10.7 Ω /K	$\pm 0.07 + x$	$\pm 0.11 \text{ K} + x$	± 0.07	$\pm 0.11 \text{ K}$	± 0.06	$\pm 0.09 \text{ K}$
KTY 84	6.2 Ω /K	$\pm 0.06 + x$	$\pm 0.19 \text{ K} + x$	± 0.06	$\pm 0.19 \text{ K}$	± 0.05	$\pm 0.16 \text{ K}$
Linear resistance							
0 Ω to 400 Ω		$\pm 0.025 + x$	$\pm 100 \text{ m}\Omega + x$	± 0.025	$\pm 100 \text{ m}\Omega$	± 0.019	$\pm 75 \text{ m}\Omega$
0 Ω to 4 k Ω		$\pm 0.03 + x$	$\pm 1.2 \Omega + x$	± 0.03	$\pm 1.2 \Omega$	± 0.025	$\pm 1 \Omega$

α : Average sensitivity for the calculation of tolerance values.

x: Additional error due to connection using 2-wire technology (see "Systematic Errors During Temperature Measurement In 2-Wire Technology" on page 26).

Maximum Measuring Tolerances at 25°C (77°F)

	α at 100°C (212°F)	2-Wire Technology		3-Wire Technology		4-Wire Technology	
		Relative [%]	Absolute	Relative [%]	Absolute	Relative [%]	Absolute
Temperature sensors							
PT 100	0.385 Ω /K	$\pm 0.12 + x$	$\pm 1.04 \text{ K} + x$	$\pm 0.12\%$	$\pm 1.04 \text{ K}$	$\pm 0.10\%$	$\pm 0.83 \text{ K}$
PT 1000	3.85 Ω /K	$\pm 0.15 + x$	$\pm 1.3 \text{ K} + x$	$\pm 0.15\%$	$\pm 1.3 \text{ K}$	$\pm 0.12\%$	$\pm 1.04 \text{ K}$
Ni 100	0.617 Ω /K	$\pm 0.36 + x$	$\pm 0.65 \text{ K} + x$	$\pm 0.36\%$	$\pm 0.65 \text{ K}$	$\pm 0.29\%$	$\pm 0.52 \text{ K}$
Ni 1000	6.17 Ω /K	$\pm 0.45 + x$	$\pm 0.81 \text{ K} + x$	$\pm 0.45\%$	$\pm 0.81 \text{ K}$	$\pm 0.36\%$	$\pm 0.65 \text{ K}$
Cu 50	0.213 Ω /K	$\pm 0.47 + x$	$\pm 0.94 \text{ K} + x$	$\pm 0.47\%$	$\pm 0.94 \text{ K}$	$\pm 0.38\%$	$\pm 0.75 \text{ K}$
Ni 1000 L&G	5.6 Ω /K	$\pm 0.56 + x$	$\pm 0.89 \text{ K} + x$	$\pm 0.56\%$	$\pm 0.89 \text{ K}$	$\pm 0.44\%$	$\pm 0.71 \text{ K}$
Ni 500 Viessmann	2.8 Ω /K	$\pm 0.72 + x$	$\pm 1.79 \text{ K} + x$	$\pm 0.72\%$	$\pm 1.79 \text{ K}$	$\pm 0.57\%$	$\pm 1.43 \text{ K}$
KTY 81-110	10.7 Ω /K	$\pm 0.31 + x$	$\pm 0.47 \text{ K} + x$	$\pm 0.31\%$	$\pm 0.47 \text{ K}$	$\pm 0.25\%$	$\pm 0.37 \text{ K}$
KTY 84	6.2 Ω /K	$\pm 0.27 + x$	$\pm 0.81 \text{ K} + x$	$\pm 0.27\%$	$\pm 0.81 \text{ K}$	$\pm 0.22\%$	$\pm 0.65 \text{ K}$
Linear resistance							
0 Ω to 400 Ω		$\pm 0.10 + x$	$\pm 400 \text{ m}\Omega + x$	$\pm 0.10\%$	$\pm 400 \text{ m}\Omega$	$\pm 0.08\%$	$\pm 320 \text{ m}\Omega$
0 Ω to 4 k Ω		$\pm 0.13 + x$	$\pm 5 \Omega + x$	$\pm 0.13\%$	$\pm 5 \Omega$	$\pm 0.10\%$	$\pm 4 \Omega$



α : Average sensitivity for the calculation of tolerance values.

x : Additional error due to connection using 2-wire technology (see "Systematic Errors During Temperature Measurement In 2-Wire Technology" on page 26).

Temperature response at -25°C to 55°C (-13°F to 131°F)

	Typical	Maximum
2-, 3-, 4-wire technology	$\pm 12 \text{ ppm}/^\circ\text{C}$	$\pm 45 \text{ ppm}/^\circ\text{C}$

Technical Data

General Data	
Housing dimensions (width x height x depth)	12.2 mm x 120 mm x 66.6 mm (0.480 in. x 4.724 in. x 2.622 in.)
Weight	46 g (without connector)
Operating mode	Process data operation with 2 words
Connection type of the sensors	2-, 3- and 4-wire technology
Permissible temperature (operation)	-25°C to +55°C (-13°F to 131°F)
Permissible temperature (storage/transport)	-25°C to +85°C (-13°F to 185°F)
Permissible humidity (operation)	75% on average, 85% occasionally (no condensation)
 In the range from -25°C to +55°C (-13°F to +131°F) appropriate measures against increased humidity (> 85%) must be taken.	
Permissible humidity (storage/transport)	75% on average, 85% occasionally (no condensation)
 For a short period, slight condensation may appear on the housing if, for example, the terminal is brought into a closed room from a vehicle.	
Permissible air pressure (operation)	80 kPa to 106 kPa (up to 2000 m [6561.680 ft.] above sea level)
Permissible air pressure (storage/transport)	70 kPa to 106 kPa (up to 3000 m [9842.520 ft.] above sea level)
Degree of protection	IP 20 according to IEC 60529
Class of protection	Class 3 according to VDE 0106, IEC 60536

Interface	
local bus interface	Data routing

Power Consumption	
Communications voltage U_L	7.5 V
Current consumption from U_L	43 mA, typical
I/O supply voltage U_{ANA}	24 V DC
Current consumption from U_{ANA}	11 mA, typical
Total power consumption	590 mW, typical

Supply of the Module Electronics and I/O Through Bus Terminal/Power Terminal	
Connection method	Voltage routing

Analog Inputs	
Number	Two inputs for resistive temperature sensors
Connection of the signals	2-, 3- or 4-wire, shielded sensor cable
Sensor types that can be used	Pt, Ni, Cu, KTY
Standards for characteristic curves	According to DIN / according to SAMA
Conversion time of the A/D converter	120 μ s, typical
Process data update	Dependent on the connection method
Both channels in 2-wire technology	20 ms
One channel in 2-wire technology/ one channel in 4-wire technology	20 ms
Both channels in 3-wire technology	32 ms

Safety Devices	
None	

Electrical Isolation	
	For the electrical isolation between logic level and I/O area it is necessary to provide the bus terminal supply U_{BK} and the I/O supply (U_M/U_S) from separate power supply units. Interconnection of the 24 V power supplies is not allowed!

Common Potentials
24 V main supply U_M , 24 V segment voltage U_S and GND have the same potential. FE (functional earth ground) is a separate potential area.

Isolated Voltages in the VARIO RTD 2 Terminal	
Test Distance	Test Voltage
7.5 V supply (bus logic) / 24 V analog supply (analog I/O)	500 V AC, 50 Hz, 1 min.
7.5 V supply (bus logic) / functional earth ground	500 V AC, 50 Hz, 1 min.
24 V analog supply (analog I/O) / functional earth ground	500 V AC, 50 Hz, 1 min.

Error Messages to the Higher-Level Control or Computer System	
Failure of the internal voltage supply	Yes
Failure or dropping of communications voltage U_L	Yes, I/O error message to the bus terminal

Error Messages Via Process Data	
I/O error/user error	Yes (see page 15)

Ordering Data

Description	Order Designation	Order No.
Terminal with two resistive temperature sensor inputs with connectors and labeling fields	VARIO RTD 2	KSVC-103-00321

PMA Prozess- und Maschinen-Automation GmbH
Miramstrasse 87
34123 Kassel
Germany



+49 - (0)561 505 - 1307



+49 - (0)561 505 - 1710



www.pma-online.de